



**BMW
MOTORRAD**

RIDER'S MANUAL

R 1300 GS



MAKE LIFE A RIDE

Vehicle data

Model

Vehicle Identification Number

Colour code

Date of first registration

Registration number

Dealership details

Person to contact in Service department

Ms/Mr

Phone number

Dealership address/phone number (company stamp)

YOUR BMW.

We congratulate you on your choice of a vehicle from BMW Motorrad and welcome you to the community of BMW riders. Familiarise yourself with your new vehicle so that you can ride it safely and confidently in all traffic situations.

About this rider's manual

Read this rider's manual carefully before starting your new BMW. It contains important information on how to operate the controls and how to make the best possible use of all your BMW's technical features.

In addition, it contains information on maintenance and care to help you maintain your vehicle's reliability and safety, as well as its value.

If the time comes to sell your BMW, please remember to hand over this rider's manual to the new owner. It is an important part of the vehicle.

We hope you will enjoy riding your BMW and that all your journeys will be pleasant and safe

BMW Motorrad.

01 GENERAL INSTRUCTIONS 2

Quick & easy reference	4
Abbreviations and symbols	4
Equipment	5
Technical data	5
Currency	6
Additional sources of information	6
Certificates and operating licences	6
Data memory	7
Bluetooth	11
Connectivity functions	12
Intelligent emergency call system	12

02 GENERAL VIEWS 16

General view, left side	18
General view, right side	19
Underneath the seat	20
Multifunction switch, left	21
Multifunction switch, right	22
Multifunction switch, right	23
Instrument cluster	24

03 STATUS INDICATORS 26

Indicator and warning lights	28
Menu view	29
Pure Ride view	30
Sport view	33
My Vehicle view	34
Warning indicators	37

04 INSTRUMENT CLUSTER 74

Warnings	76
Controls	76
Multi-function rocker switch menus	77
My vehicle Settings	80
Bluetooth pairing	81
Operating focus	82
Navigation	84
Media	85
Telephone	87
Software version	88
Licence information	88

05 OPERATION 90

Ignition	92
Emergency-off switch (kill switch)	97
Intelligent emergency call	97
Lighting	100

Dynamic Traction Control (DTC)	103	Handlebars	143
Dynamic Suspension Adjustment (DSA)	103	Spring preload	144
Riding mode	105		
Riding mode Pro	108	07 RIDING	146
Cruise control	109	Safety information	148
Radar-based rider assistance systems	112	Regular check	151
Distance control (Active Cruise Control ACC)	114	Starting	152
Front Collision Warning (FCW)	118	Running in	155
Lane change warning (SWW)	120	Off-road use	156
Hill Start Control (HSC)	121	Shifting gear	157
Anti-theft alarm (DWA)	124	Brakes	158
Tyre pressure monitoring (RDC)	127	Parking your motorcycle	160
Windscreen	127	Lift assistance	161
Heating	128	Refuelling	163
Central locking system	130	Securing motorcycle for transportation	166
Storage compartment	132		
Front and rear seats	133	08 ENGINEERING DETAILS	170
		General notes	172
06 ADJUSTMENT	136	Antilock Brake System (ABS)	172
Mirrors	138	Dynamic Traction Control (DTC)	176
Headlight	139	Dynamic engine brake control (MSR)	178
Clutch	140	Battery Guard	178
Gearshift lever	140	Shutdown concept	179
Brakes	141	Distance control (Active Cruise Control ACC)	180
Footrests	142	Front Collision Warning (FCW)	182

Lane change warning (SWW)	183
Dynamic Suspension Adjustment (DSA)	184
Riding mode	185
Dynamic Brake Control	190
Tyre pressure control (RDC)	190
Gear Shift Assistant Hill Start Control (HSC)	193
ShiftCam	195
Cornering headlight	195

09 MAINTENANCE 198

General notes	200
Toolkit	201
Front-wheel stand	201
Rear-wheel stand	202
Engine oil	202
Brake system	204
Clutch	209
Coolant	209
Tyres	210
Wheel rims	212
Wheels	212
Air filter	220
Side panel	221
Lighting	223
Jump-starting	223
Battery	225
Fuses	231
Diagnostic connector	233

10 ACCESSORIES 234

General notes	236
Power sockets	236
USB charging sockets	237
Cases	239
Topcase	244
Navigation system	249

11 CARE 252

Care products	254
Washing the vehicle	254
Cleaning easily damaged components	255
Care of paintwork	256
Paint preservation	257
Laying up motorcycle	257
Restoring motorcycle to use	258

12 TECHNICAL DATA 260

Troubleshooting chart	262
Threaded fasteners	264
Fuel	267
Engine oil	268
Engine	268
Clutch	269
Transmission	269
Final drive	269
Frame	269
Chassis and suspension	270
Brakes	270
Wheels and tyres	271
Electrical system	272
Anti-theft alarm	273

Dimensions	273	Radio equipment	
Weights	275	tyre pressure control	
Performance figures	275	(RDC)	316
		Radio equipment in-	
13 SERVICE	276	telligent emergency	
		call	317
Reporting safety-rel-			
evant defects	278		
Recycling	279	INDEX	320
BMW Motorrad			
Service	279		
BMW Motorrad			
service history	280		
BMW Motorrad mo-			
bility services	280		
Maintenance work	280		
Maintenance sched-			
ule	282		
BMW Motorrad run-			
ning-in check	283		
Maintenance confirm-			
ations	284		
Service confirmations	296		
APPENDIX	298		
Declaration of Con-			
formity	299		
Radio equipment TFT			
instrument cluster	303		
Keyless Ride System			
Main Unit	304		
Keyless Ride System			
Active Key	307		
Mid Range Radar	311		
Short Range Radar	314		

GENERAL INSTRUCTIONS

01

QUICK & EASY REFERENCE	4
ABBREVIATIONS AND SYMBOLS	4
EQUIPMENT	5
TECHNICAL DATA	5
CURRENCY	6
ADDITIONAL SOURCES OF INFORMATION	6
CERTIFICATES AND OPERATING LICENCES	6
DATA MEMORY	7
BLUETOOTH	11
CONNECTIVITY FUNCTIONS	12
INTELLIGENT EMERGENCY CALL SYSTEM	12

4 GENERAL INSTRUCTIONS

QUICK & EASY REFERENCE

An important aspect of this rider's manual is that it can be used for quick and easy reference. Consulting the extensive index at the end of this rider's manual is the fastest way to find information on a particular topic or item. To first read an overview of your vehicle, please go to Chapter 2. All maintenance and servicing work on the vehicle is documented in the "Service" section. The record of the maintenance work you have had performed on your vehicle is a precondition for generous treatment of goodwill claims.

ABBREVIATIONS AND SYMBOLS

 **CAUTION** Low-risk hazard. Non-avoidance can lead to slight or moderate injury.

 **WARNING** Medium-risk hazard. Non-avoidance can lead to fatal or severe injury.

 **DANGER** High-risk hazard. Non-avoidance leads to fatal or severe injury.

 **ATTENTION** Special notes and precautionary measures. Non-compliance can lead to damage to the vehicle or accessory and, consequently, to voiding of the warranty.

 Specific instructions on how to operate, control, adjust or look after items of equipment on the motorcycle.

- Instruction.
- » Result of an activity.
- ▣ Reference to a page with more detailed information.
- ◁ Indicates the end of a passage relating to specific accessories or items of equipment.



Tightening torque.



Technical data.

NV

National-market version.

OE	Optional equipment. The vehicles are assembled complete with all the BMW Motorrad optional equipment originally ordered.	RDC	Tyre pressure monitoring.
OA	Optional accessories. You can obtain BMW Motorrad optional accessories through your authorised BMW Motorrad dealer; optional accessories have to be retrofitted to the vehicle.	SWW	Lane change warning.
ABS	Anti-lock brake system.		
ACC	Distance control (Active Cruise Control).		
DSA	Dynamic Suspension Adjustment.		
DTC	Dynamic Traction Control.		
DWA	Anti-theft alarm.		
EWS	Electronic immobiliser.		
FCW	Front Collision Warning.		
MSR	Dynamic engine brake control.		

EQUIPMENT

When you ordered your BMW Motorrad, you chose various items of custom equipment. This rider's manual describes optional equipment (OE) and selected optional accessories (OA) provided by BMW. This explains why the manual may also contain descriptions of equipment that you might not have selected. Please note, too, that on account of country-specific differences, your motorcycle might not be exactly as illustrated.

If your motorcycle contains equipment that has not been described, its description can be found in a separate manual.

TECHNICAL DATA

All dimensions, weights and power ratings stated in the rider's manual are quoted to the standards and comply with the tolerance requirements of the Deutsches Institut für Normung e. V. (DIN).

6 GENERAL INSTRUCTIONS

Technical data and specifications in this rider's manual are guide values. The vehicle-specific data may deviate from these, for example as a result of selected optional equipment, the national-market version or country-specific measuring procedures. Detailed values can be taken from the vehicle registration documents, or can be obtained from your authorised BMW Motorrad retailer or another qualified service partner or specialist workshop. The specifications in the vehicle documents always have priority over the information provided in this rider's manual.

CURRENCY

The high safety and quality standards of BMW motorcycles are maintained by constant development work on designs, equipment and accessories. Because of this, your vehicle may differ from the information supplied in the rider's manual. At the time of production of the motorcycle, the rider's manual is the most up-to-date source. Owing to updates subsequent to the date of publication, differences between the printed rider's

manual and the online version are possible.

Up-to-date information is available at **bmw-motorrad.com/service**.

ADDITIONAL SOURCES OF INFORMATION

Authorised BMW Motorrad retailer

Your authorised BMW Motorrad retailer will be happy to answer any questions you may have.

Internet

The rider's manual for your vehicle, operating and installation instructions for accessories and general information about BMW Motorrad, in relation to technology, for example, are available for download from **bmw-motorrad.com/manuals**.

CERTIFICATES AND OPERATING LICENCES

The certificates for the vehicle and the official operating licences for accessories can be downloaded from **bmw-motorrad.com/certification**.

DATA MEMORY

General

Control units are installed in the vehicle. Control units process data that they receive, for example, from vehicle sensors, or that they generate themselves or exchange between each other. Some control units are required for the vehicle to function safely or provide assistance during riding, for example assistance systems. In addition, control units enable comfort or infotainment functions.

Information on data that has been stored or exchanged can be obtained from the manufacturer of the vehicle, for example via a separate booklet.

Personal reference

Each vehicle is identified with a clear vehicle identification number. Depending on the country, the vehicle identification number, the number plate and the corresponding authorities can be referenced to ascertain the vehicle owner. There are also other ways to use data obtained from the vehicle to trace the rider or vehicle owner, for example using the Connected-Drive user account.

Data protection rights

In accordance with applicable data protection laws, vehicle users have certain rights in relation to the manufacturer of the vehicle or in relation to companies which collect or process personal data.

Vehicle users have the right to obtain full information at no cost from persons or entities storing personal data of the vehicle user.

These entities may include:

- Manufacturer of the vehicle
- Qualified service partners
- Specialist workshops
- Service providers

Vehicle users have the right to request information on what personal data has been stored, for what purpose the data is used, and where the data comes from. To obtain this information, proof of ownership or use is required.

The right to information also includes information about data that has been shared with other companies or entities. The website of the vehicle manufacturer contains the applicable data protection information. This data protection information includes information on the right to

8 GENERAL INSTRUCTIONS

have data deleted or corrected. The manufacturer of the vehicle also provides their contact details and those of the data protection officer on their website.

The vehicle owner can also request that a BMW Motorrad retailer or another qualified service partner or specialist workshop read out the data that is stored in the vehicle for a charge.

The vehicle data is read out using the legally prescribed socket for on-board diagnosis (OBD) in the vehicle.

Legal requirements for the disclosure of data

As part of its legal responsibilities, the manufacturer of the vehicle is obligated to make its stored data available to the relevant authorities. This data is provided in the required scope in individual cases, for example to clarify a criminal offence. In the context of applicable laws, public agencies are entitled in individual cases to read out data from the vehicle themselves.

Operating data in the vehicle

Control units process data to operate the vehicle.

This includes, for example:

- Status reports of the vehicle and its individual components, for example wheel speed, wheel circumferential velocity, deceleration
- Environmental conditions, for example temperature

The data is only processed in the vehicle itself and is generally non-permanent. The data is not stored beyond the operating period.

Electronic components, for example control units, contain components for storing technical information. Information can be temporarily or permanently stored on the vehicle condition, component loads, incidents or errors.

This information is generally used to document the condition of a component, a module, a system or the surrounding area, for example:

- Operating conditions of system components, for example filling levels, tyre pressure
- Malfunctions and faults in important system components, for example light and brakes

- Response of the vehicle in special riding situations, for example engagement of the driving dynamics systems
- Information on incidents resulting in damage to the vehicle

The data is necessary for the provision of control unit functions. Furthermore, the data is used to detect and rectify malfunctions and to enable the vehicle manufacturer to optimise vehicle functions.

The vast majority of this data is non-permanent and is only processed in the vehicle itself. Only a small amount of the data is stored in incident or fault memories as required by events.

If services are accessed, for example repairs, service processes, warranty cases and quality assurance measures, this technical information can be read out of the vehicle together with the vehicle identification number.

The information can be read out by a BMW Motorrad retailer or another qualified service partner or specialist workshop. The legally stipulated socket for on-board

diagnosis (OBD) in the vehicle is used to read out the data. The data is obtained, processed and used by the relevant parts of the retailer network. The data is used to document the technical conditions of the vehicle, to help with error localization, to comply with warranty obligations and to improve quality.

In addition, the manufacturer has various product monitoring obligations arising from product liability legislation. To meet these obligations, the vehicle manufacturer requires technical data from the vehicle. The data from the vehicle can also be used to check warranty claims from the customer. Error and incident memories in the vehicle can be reset during servicing or repair work by a BMW Motorrad retailer or another qualified service partner or specialist workshop.

Data input and data transfer in the vehicle

General

Depending on the equipment, comfort and customised settings can be stored in the

10 GENERAL INSTRUCTIONS

vehicle and can be changed or reset at any time.

If required, data can be entered in the entertainment and communication system of the vehicle, for example using a smartphone.

Depending on the individual equipment, this includes:

- Multimedia data, such as music for playback
- Contacts data for use in connection with a communication system or an integrated navigation system
- Entered destinations
- Data on the use of internet services. This data can be stored locally in the vehicle or is located on a device that is connected to the vehicle, for example smartphone, USB stick, MP3 player. If this data is stored in the vehicle, the data can be deleted at any time.

This data is transferred to third parties only if personally requested within the context of using online services. This depends on the selected settings when using the services.

Incorporation of mobile devices

Depending on the equipment, mobile devices connected to the vehicle, for example smartphones, can be controlled using the operating elements of the vehicle.

The image and sound of the mobile device can then be output via the multimedia system. At the same time, specific information is transferred to the mobile device. Depending on the type of integration, this includes, for example, position data and additional general vehicle information. This enables optimal use of the selected apps, for example navigation or music playback.

The type of additional data processing is determined by the provider of the respective app. The scope of the possible settings depends on the corresponding app and the operating system of the mobile device.

Services

General

If the vehicle has a wireless connection, this enables the exchange of data between the vehicle and other systems. The wireless connection

is enabled by the vehicle's own transceiver unit or using personally integrated mobile devices, for example smartphones. Online functions can be accessed through this wireless connection. These include online services and apps that are provided by the vehicle manufacturer or by other providers.

Services of the vehicle manufacturer

For online services of the vehicle manufacturer, the individual functions are described at suitable points, for example rider's manual, website of the manufacturer. At the same time, information is also provided on the relevant data protection law. Personal data may be used to provide online services. Data is exchanged using a secure connection, for example with the IT systems provided by the vehicle manufacturer.

Obtaining, processing and using personal data outside of the normal provision of services requires legal permission, contractual agreement or consent. It is also possible to have the entire data connection activated or deactivated. Stat-

utory functions are excluded from this.

Services from other providers

When using online services from other providers, these services are subject to the responsibility and the data protection and operating conditions of the individual provider. The vehicle manufacturer has no influence on the content that is exchanged in this instance. Information on the type, scope and purpose of the data capture and use of personal data as part of the services of third parties can be ascertained from the individual provider.

BLUETOOTH

Bluetooth is a short-range wireless technology. Bluetooth devices are short-range devices transmitting on the license-free ISM band (Industrial, Scientific, Medical) between 2.402...2.480 GHz. They can be operated anywhere in the world without a licence being required.

Although Bluetooth is designed to establish and sustain robust connections over short distances, as with every other

12 GENERAL INSTRUCTIONS

wireless technology disruptions are possible. Interference can affect connections or connections can sometimes fail. Particularly when multiple devices operate in a Bluetooth network, with wireless technology of this nature it is not possible to ensure fault-free communications in every situation.

Possible sources of interference:

- Interference zones due to transmission masts and similar.
- Devices with non-compliant Bluetooth implementations.
- Proximity of other Bluetooth-compatible devices.
- Shielding by metal objects or bodies.

CONNECTIVITY FUNCTIONS

Connectivity functions include media, telephony and navigation. Connectivity functions can be used when the instrument cluster is connected to a mobile device and a helmet (▶▶▶ 82). For more information on the Connectivity functions go to:

bmw-motorrad.com/connectivity

 Depending on the mobile end device, the scope of Connectivity functions might be restricted.

BMW Motorrad Connected app

The BMW Motorrad Connected app enables the user to call up usage data and vehicle status information. For some functions such as navigation, for example, the app has to be installed on the mobile device and paired to the instrument cluster. The app is used to start route guidance and adjust the navigation.

 On some mobile devices, e.g. those with the iOS operating system, the BMW Motorrad Connected app has to be opened prior to use.

INTELLIGENT EMERGENCY CALL SYSTEM

–with intelligent emergency call^{OE}

Principle

The intelligent emergency call system enables manual or automatic emergency calls, for example in the event of an accident.

The emergency calls are received by an emergency call

centre that is commissioned by the vehicle manufacturer.

For information on operating the intelligent emergency call system and its functions see (▣▣▣ 97).

Legal basis

Processing of personal data using the intelligent emergency call system is in line with the following regulations:

- Protection of personal data: Directive 95/46/EC of the European Parliament and of the Council.
- Protection of personal data: Directive 2002/58/EC of the European Parliament and of the Council.

The legal basis for the activation and function of the intelligent emergency call system is the concluded Connected-Ride contract for this function, as well as the corresponding laws, ordinances and directives of the European Parliament and of the European Council.

The relevant ordinances and directives regulate the protection of natural persons during the processing of personal data.

The processing of personal data by the intelligent emer-

gency call system satisfies the European directives for the protection of personal data. The intelligent emergency call system processes personal data only with the agreement of the vehicle owner.

The intelligent emergency call system and other services with additional benefits can process personal data only with the express permission of the person affected by the data processing, for example the vehicle owner.

SIM card

The intelligent emergency call system operates via the mobile phone network using the SIM card installed in the vehicle. The SIM card is permanently logged into the mobile phone network to enable rapid connection setup. Data is sent to the vehicle manufacturer in the event of an emergency.

Improving quality

The data that is transferred in an emergency is also used by the manufacturer of the vehicle to improve product and service quality.

14 GENERAL INSTRUCTIONS

Location determination

The position of the vehicle can be determined exclusively by the mobile phone network provider based on the mobile phone site locations. It is not possible for the provider to trace a connection between the vehicle's VIN and the phone number of the installed SIM card. Only the manufacturer of the vehicle can link a VIN and the phone number of the SIM card installed in a particular vehicle.

Log data of emergency calls

The log data of emergency calls is stored in a memory of the vehicle. The oldest log data is regularly deleted. The log data includes, for example, information on when and where an emergency call was made. In exceptional cases, the log data can be read out of the vehicle memory. As a rule, log data is only read out following a court order, and this is only possible if the corresponding devices are connected directly to the vehicle.

Automatic emergency call

The system is designed so that, following a sufficiently serious accident, which is detected by sensors in the vehicle, an emergency call is automatically activated.

Sent information

When making an emergency call using the intelligent emergency call system, the system forwards the same information to the designated emergency call centre as is forwarded to the public emergency operations centre by the statutory emergency call system eCall. In addition, the intelligent emergency call system sends the following additional information to an emergency call centre commissioned by the vehicle manufacturer and, if required, to the emergency services:

- Accident data, for example the direction of impact detected by the vehicle sensors, to assist the emergency services response.
- Contact details, for example the phone number of the installed SIM card and the phone number of the rider, if available, to enable rapid

contact with those involved in the accident if required.

Data storage

The data for an activated emergency call is stored in the vehicle. The data contains information on the emergency call, for example the location and time of the emergency call. The voice recordings of the emergency call are stored at the emergency call centre. The voice recordings of the customer are stored for 24 hours in case details of the emergency call need to be analysed. After this, the voice recordings are deleted. The voice recordings of the employee of the emergency call centre are stored for 24 hours for quality assurance purposes.

Information on personal data

The data that is processed as part of the intelligent emergency call is processed exclusively to carry out the emergency call. As part of its statutory obligation, the manufacturer of the vehicle provides information about the data that it has processed and any data that it still has stored.

GENERAL VIEWS

02

GENERAL VIEW, LEFT SIDE	18
GENERAL VIEW, RIGHT SIDE	19
UNDERNEATH THE SEAT	20
MULTIFUNCTION SWITCH, LEFT	21
MULTIFUNCTION SWITCH, RIGHT	22
MULTIFUNCTION SWITCH, RIGHT	23
INSTRUMENT CLUSTER	24

18 GENERAL VIEWS

GENERAL VIEW, LEFT SIDE

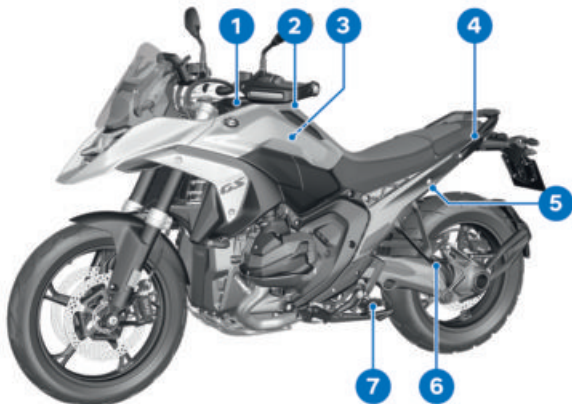

- 1 Table of tyre pressures
Payload table
USB charging interface
(underneath the storage compartment lid)
(238)
- 2 Fuel filler neck (164)
- 3 Air filter (underneath side panel, left) (220)
- 4 Passenger grab handle
- 5 Seat lock (133)
- 6 Rear footrest
- 7 Rider footrest

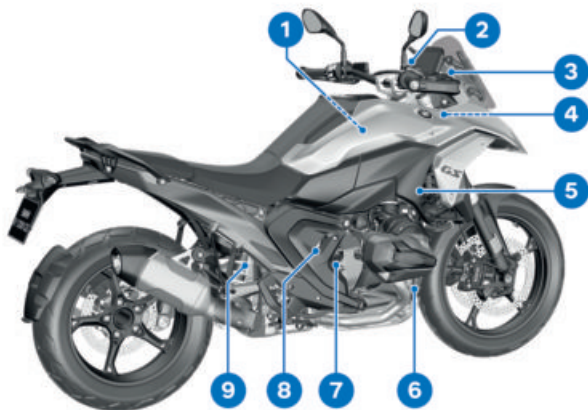
GENERAL VIEW, RIGHT SIDE

- | | |
|---|---|
| 1 Air filter (underneath side panel, right) (☞ 220) | 7 Oil filler opening (☞ 204) |
| 2 Brake-fluid reservoir, front (☞ 207) | 8 Brake-fluid reservoir, rear (☞ 208) |
| 3 Power socket (☞ 236) | 9 Spring preload at rear wheel (☞ 145) |
| 4 Vehicle identification number (on steering head)
Type plate (on the frame, front right) | |
| 5 Coolant-level indicator (☞ 209)
Coolant reservoir (☞ 210) | |
| 6 Engine oil level indicator (☞ 202) | |

20 GENERAL VIEWS

UNDERNEATH THE SEAT

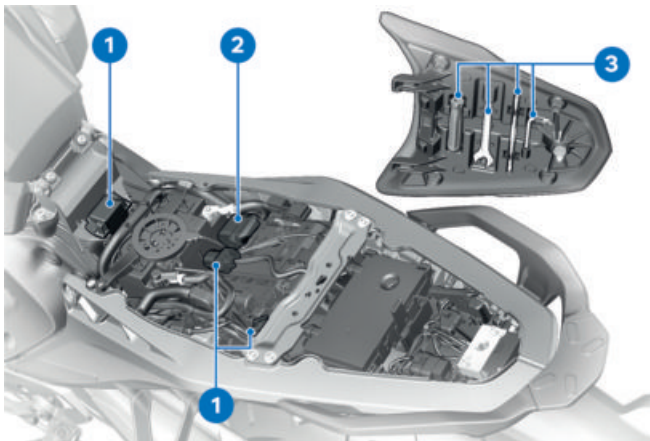

- 1 Fuses (☞ 231)
- 2 Diagnostic connector (☞ 233)
- 3 Toolkit (☞ 201)

MULTIFUNCTION SWITCH, LEFT



- 1 High-beam headlight and headlight flasher (➡ 100)
- 2 Cruise control (➡ 109)
- 3 Hazard warning lights (➡ 102)
- 4 Multi-function rocker switch (➡ 78)
- 5 Turn indicators (➡ 102)
- 6 Horn
- 7 MENU rocker button (➡ 77)
- 8 Multi-Controller (➡ 76)
- 9 Functions list (➡ 78)

22 GENERAL VIEWS

MULTIFUNCTION SWITCH, RIGHT

–without intelligent emergency call^{OE}



- 1** Steering lock
Central locking system
Ignition (➡ 93)
- 2** Riding mode (➡ 105)
- 3** Emergency-off switch (kill switch) (➡ 97)
- 4** Starting engine (➡ 152)

MULTIFUNCTION SWITCH, RIGHT–with intelligent emergency call^{OE}

- 1** Steering lock
Central locking system
Ignition (➡ 93)
- 2** Riding mode (➡ 105)
- 3** Emergency-off switch (kill switch) (➡ 97)
- 4** Starter button (➡ 152)
- 5** SOS button
Intelligent emergency call
(➡ 152)

24 GENERAL VIEWS

INSTRUMENT CLUSTER

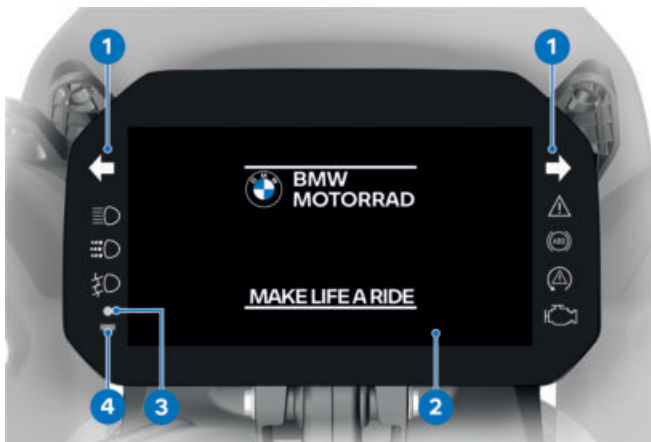

- 1 Indicator and warning lights (➡ 28)
- 2 Instrument cluster (➡ 30)
- 3 Indicator light
DWA (➡ 125)
Keyless Ride (➡ 93)
- 4 Photosensor (for automatic measurement of ambient brightness)

STATUS INDICATORS

03

INDICATOR AND WARNING LIGHTS	28
MENU VIEW	29
PURE RIDE VIEW	30
SPORT VIEW	33
MY VEHICLE VIEW	34
WARNING INDICATORS	37

28 STATUS INDICATORS

INDICATOR AND WARNING LIGHTS

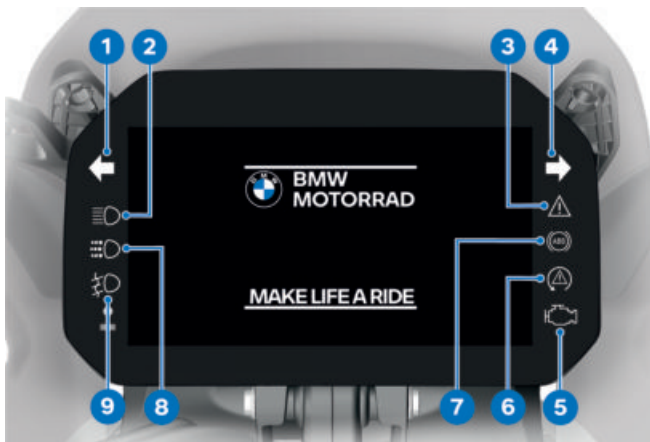

- 1 Turn indicators, left (➡ 102)
- 2 High-beam headlight (➡ 100)
- 3 General warning light (➡ 37)
- 4 Turn indicators, right (➡ 102)
- 5 Warning light, drive malfunction (➡ 55)
- 6 DTC (➡ 63)
- 7 ABS (➡ 62)
- 8 Automatic daytime riding light (➡ 101)
- 9 Auxiliary headlights (➡ 101)

MENU VIEW

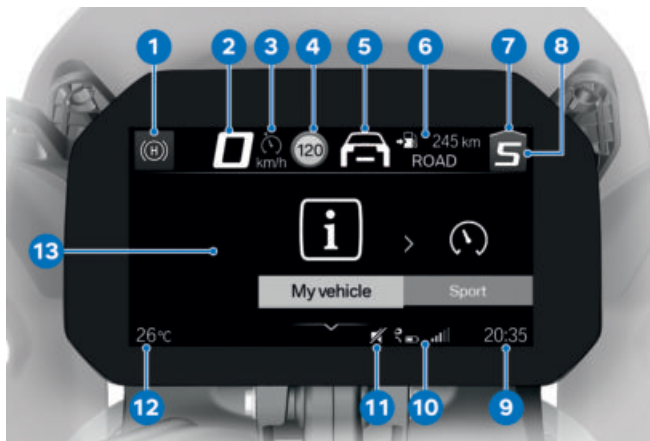

- | | |
|--|--------------------------------------|
| 1 Hill Start Control (➡ 68) | 12 Ambient temperature (➡ 47) |
| 2 Speedometer | 13 Menu section |
| 3 Cruise control (➡ 109) | |
| 4 Speed Limit Info (➡ 87) | |
| 5 Distance control (➡ 117)
Front collision warning (➡ 119) | |
| 6 Rider info. status line (➡ 81) | |
| 7 Recommendation to up-shift (➡ 32) | |
| 8 Gear indicator | |
| 9 Clock (➡ 82) | |
| 10 Connection status | |
| 11 Muting (➡ 82) | |

30 STATUS INDICATORS

PURE RIDE VIEW

START SCREEN

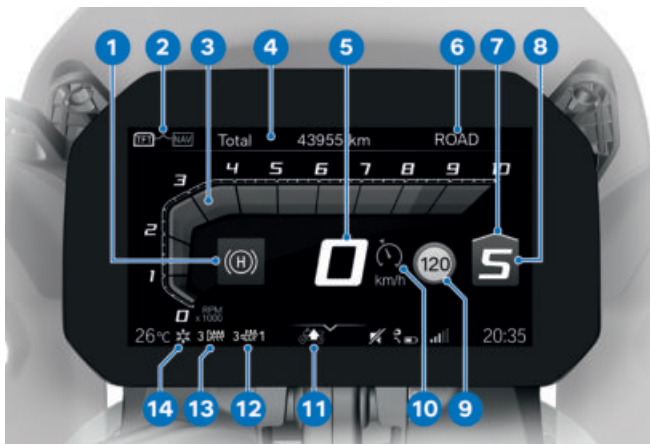

- | | |
|--|--|
| 1 Hill Start Control (➡ 68) | 13 Heated grips (➡ 128) |
| 2 Change of operating focus (➡ 84) | 14 Outside temperature warning (➡ 47) |
| 3 Rev. counter (➡ 31) | |
| 4 Rider info. status line (➡ 81) | |
| 5 Speedometer | |
| 6 Riding mode (➡ 105) | |
| 7 Recommendation to up-shift (➡ 32) | |
| 8 Gear indicator | |
| 9 Speed Limit Info (➡ 87) | |
| 10 Cruise control (➡ 109) | |
| 11 Ride height (➡ 104) | |
| 12 Seat heating (➡ 129) | |

REV. COUNTER



- 1 Scale
- 2 Engine speed range
- 3 Upper/red engine speed range
- 4 Needle
- 5 Secondary indicator
- 6 Unit for engine speed display:
1000 revolutions per minute

The warmer the engine, the higher the speed at which the red engine speed range starts. When operating temperature is reached, the display of the red engine speed range no longer changes.

 The red engine speed range changes depending on the coolant temperature: The colder the engine, the lower the engine speed at which the red engine speed range starts.

32 STATUS INDICATORS

Range



Range readout **1** indicates how far you can ride with the fuel remaining in the tank. This distance is calculated on the basis of average consumption and the quantity of fuel on board.

–When the vehicle is propped on its side stand the slight angle of inclination means that the sensor cannot register the fuel level correctly. This is the reason why the range is recalculated only when the side stand is in the retracted position.

–The range is shown together with a warning once the fuel reserve has been reached.

–After a refuelling stop, range is recalculated if the amount of fuel in the tank is greater than the reserve quantity.

–The calculated range is only an approximate figure.

Recommendation to upshift



The recommendation to upshift in the status line **1** or in the Pure Ride view **2** indicates the best time to upshift economically.

SPORT VIEW

- 1 Maximum DTC torque reduction
- 2 Actual DTC torque reduction
- 3 Rev. counter
- 4 Maximum heel angle, left
- 5 Actual heel angle in corners for left and right
- 6 Maximum heel angle, right
- 7 Current retardation rate during braking
- 8 Maximum retardation rate

34 STATUS INDICATORS

MY VEHICLE VIEW

START SCREEN

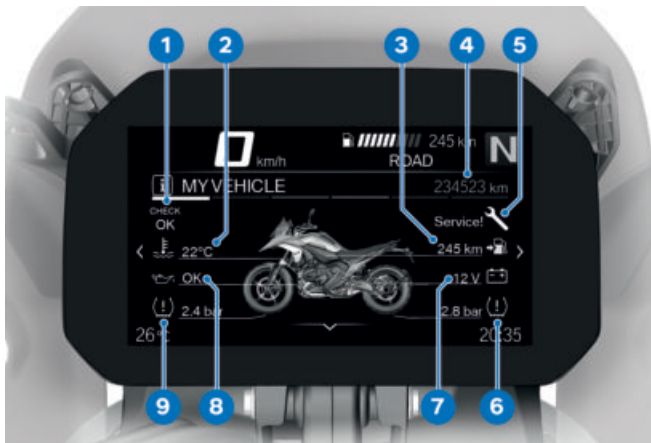

- 1 Check Control display
Mode of presentation
(⇒ 37)
- 2 Coolant temperature
(⇒ 54)
- 3 Range (⇒ 32)
- 4 Odometer
- 5 Service display (⇒ 72)
- 6 Tyre pressure, rear
(⇒ 35)
- 7 On-board voltage
(⇒ 226)
- 8 Engine oil level (⇒ 54)
- 9 Tyre pressure, front
(⇒ 35)

On-board computer and trip computer

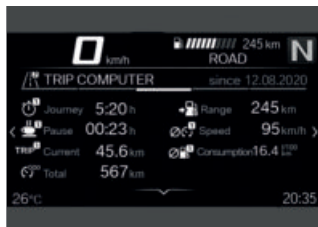

The ON-BOARD COMPUTER and TRIP COMPUTER menu screens display vehicle and trip data, such as average values.

Tyre pressure

In addition to the MY VEHICLE menu screen and the Check Control messages, there is also the TYRE PRESSURE screen for showing the tyre pressures:

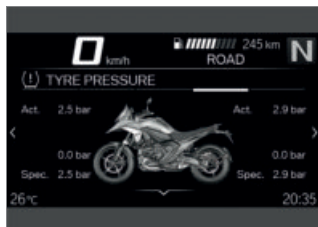

The values on the left are for the front wheel; those on the right are for the rear wheel. Actual and specified tyre pressures and the difference

between them are displayed for each wheel.

Immediately after the ignition is switched on, only dashes are displayed. The sensors do not start transmitting tyre pressure signals until the first time the vehicle accelerates to more than the minimum speed stated below:



RDC sensor is not active

min 30 km/h (The RDC sensor does not transmit its signal to the vehicle until a certain minimum speed has been reached.)



The tyre-pressure readings in the instrument cluster are temperature-compensated and are always referenced to the following tyre-air temperature:

20 °C



If the tyre symbol appears as well, showing yellow or red, this is a warning. The pressure difference is highlighted with an exclamation point in the same colour.

36 STATUS INDICATORS

 If the value in question is close to the limit of the permissible tolerance range, the reading is accompanied by the 'General' warning light showing yellow.

 The 'General' warning light flashes red if the tyre pressure registered by the sensor is outside the permissible tolerance range.

For further information about BMW Motorrad RDC, see the section entitled "Engineering details" (▮▮▮▮ 190).

Service requirements

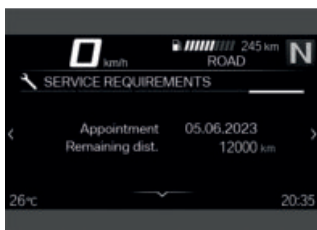

When the next service is due within less than a month or within 1000 km, a white Check Control message is displayed.

WARNING INDICATORS

Mode of presentation

Warnings are indicated by the corresponding warning lights. Warnings are indicated by the 'General' warning light showing in combination with a dialogue in the instrument cluster. The 'General' warning light shows yellow or red, depending on the urgency of the warning.

 The status of the 'General' warning light matches the most urgent warning. The possible warnings are listed on the next pages.

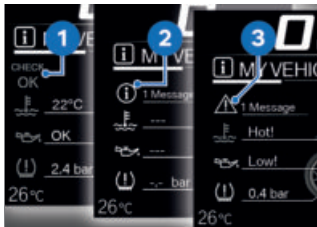

Check Control display

The messages differ in how they show on the display. Different colours and symbols are used depending on priority:

- Green CHECK OK **1**: no message, optimum values.
- White circle with small "i" **2**: information.
- Yellow warning triangle **3**: warning, value not ideal.
- Red warning triangle **3**: warning, value critical

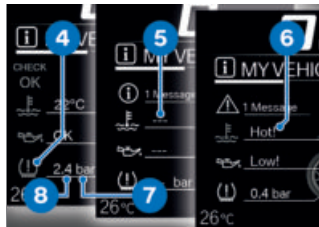

Values display

Symbols **4** differ in how they show on the display. The colours used differ and reflect the urgency of the message. Along with numerical values **8** with units **7**, texts **6** are displayed as well:

Colour of the symbol

- Green: (OK) Current value is ideal.
- Blue: (Cold!) Current temperature is low.
- Yellow: (Low!/High!) Current value is too low or too high.
- Red: (Hot!/High!) Current temperature or value is too high.

38 STATUS INDICATORS

–White: (---) No valid value available. Dashes **5** are displayed instead of a numerical value.

 To some extent, individual values can be processed only after the vehicle has covered a certain distance or has reached a certain speed. Dashes are displayed as placeholders for as long as a measured value cannot be displayed because the preconditions for measurement have still to be met. If there are no valid measured values, there will be no assessment in the form of a coloured symbol.

their occurrence until they are acknowledged.

- If symbol **2** is actively displayed, it can be acknowledged by tilting the Multi-Controller to the left.
- Check Control messages are attached dynamically to the pages as additional tabs in the `My vehicle` menu. The message can be called up again as long as the fault persists.

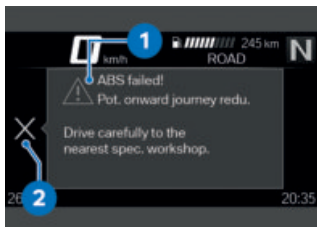



















Check Control dialogue





















Messages are output as Check Control dialogues **1**.



















- If there are two or more Check Control messages of equal priority, the messages keep changing in the order of

Warnings, overview



















Indicator and warning lights	Display text	Meaning
	 is displayed.	Outside temperature warning (►►► 47)
 lights up yellow.	 Remote key not in range.	Radio-operated key out of range (►►► 47)
 lights up yellow.	 Keyless Ride failure	Keyless Ride failed (►►► 48)
 lights up yellow.	 Remote key battery weak.	Replacing battery of radio-operated key (►►► 48)
	 is displayed in yellow.	Voltage of the vehicle electrical system too low (►►► 48)
	 Vehicle voltage low.	
 lights up yellow.	 is displayed in yellow.	Voltage of the vehicle electrical system critical (►►► 49)
	 Vehicle voltage critical!	
 flashes yellow.	 is displayed in yellow.	Charging voltage critical (►►► 49)
	 Battery voltage critical!	
 lights up yellow.	 Fault in the on-board battery.	Fault in the vehicle battery (►►► 50)
 lights up yellow.	 On-board battery overheated.	Vehicle battery overheated (►►► 50)

















40 STATUS INDICATORS

Indicator and warning lights	Display text	Meaning
 flashes red.	 Serious fault in the power supply!	Serious fault in the power supply (→ 51)
 lights up yellow.	 The faulty bulb is displayed.	Bulb faulty (→ 51)
 flashes yellow.	 The faulty bulb is displayed.	
 lights up yellow.	 Light control failure!	Light control failed (→ 52)
	 Alarm system batt. capacity weak.	Anti-theft alarm battery weak (→ 52)
	 Alarm system battery empty.	Anti-theft alarm battery flat (→ 53)
	 Alarm system failure	DWA failed (→ 53)
 lights up yellow.	 Engine oil level Check engine oil level.	Engine-oil level too low (→ 54)
 lights up yellow.	 Engine temp. high!	Engine temperature high (→ 54)
 lights up red.	 Engine overheating!	Engine overheated (→ 55)
 shows.	 Engine!	Drive malfunction (→ 55)
 flashes red.	 Serious fault in the engine control!	Serious drive malfunction (→ 56)















Indicator and warning lights	Display text	Meaning
 flashes.		Serious drive malfunction (▶▶▶ 56)
 lights up yellow.	 No communication with engine control.	Engine control failed (▶▶▶ 56)
 shows.		
 lights up yellow.	 Fault in the engine control.	Engine in emergency-operation mode (▶▶▶ 56)
 flashes red.	 Serious fault in the engine control!	Serious fault in engine control (▶▶▶ 57)
 lights up yellow.	 is displayed in yellow.	Tyre pressure close to limit of permitted tolerance (▶▶▶ 57)
	 Tyre pressure does not match setpoint	
 flashes red.	 is displayed in red.	Tyre pressure outside permitted tolerance (▶▶▶ 58)
	 Tyre pressure does not match setpoint	
	 Tyre press. control. Loss of pressure.	
	 "----"	Transmission fault (▶▶▶ 59)
 lights up yellow.	 "----"	Sensor faulty or system fault (▶▶▶ 59)















42 STATUS INDICATORS

Indicator and warning lights	Display text	Meaning
 lights up yellow.	 Tyre pressure check failure!	Tyre pressure monitoring (RDC) failed (▶▶▶▶ 60)
 lights up yellow.	 RDC sensor battery weak.	Battery for tyre pressure sensor weak (▶▶▶▶ 60)
	 Drop sensor faulty.	Malfunction, drop sensor (▶▶▶▶ 60)
	 Cannot start engine.	Motorcycle dropped (▶▶▶▶ 61)
 lights up yellow.	 Emergency call system restricted.	Emergency call function restricted (▶▶▶▶ 61)
 lights up yellow.	 Emergency call system error.	Emergency call function failed (▶▶▶▶ 61)
 lights up yellow.	 Side stand monitoring faulty.	Malfunction, side stand monitor (▶▶▶▶ 61)
 flashes regularly.		ABS self-diagnosis not completed (▶▶▶▶ 62)
 lights up yellow.	 Limited ABS availability!	ABS fault (▶▶▶▶ 62)
 shows.		
 lights up yellow.	 ABS failure!	ABS failed (▶▶▶▶ 62)
 shows.		









Indicator and warning lights	Display text	Meaning
 lights up yellow.  shows.	 ABS Pro failure!	ABS Pro failed (▣▣▣▣ 63)
 flashes irregularly.		ABS control at front wheel only (▣▣▣▣ 63)
 quick-flashes.		DTC intervention (▣▣▣▣ 63)
 slow-flashes.		DTC self-diagnosis not completed (▣▣▣▣ 64)
 shows.	 Off!	DTC switched off (▣▣▣▣ 64)
	 Traction control deactivated.	
 lights up yellow.	 Traction control limited!	DTC restricted (▣▣▣▣ 64)
 shows.		
 lights up yellow.	 Traction control failure!	DTC fault (▣▣▣▣ 65)
 shows.		
 lights up yellow.	 Damping adjustment failed.	DSA fault, damping adjustment (▣▣▣▣ 65)

44 STATUS INDICATORS

Indicator and warning lights	Display text	Meaning
 lights up yellow.	 Suspension adjustment limited.	DSA fault, suspension adjustment limited (►►► 66)
 lights up yellow.	 Suspension adjustment failed.	DSA fault, suspension adjustment unavailable (►►► 66)
 lights up yellow.	 Ride height. Lowering not possible.	DSA fault, lowering suspension (►►► 66)
 lights up yellow.	 Ride height. Raising not possible.	DSA fault, raising suspension (►►► 67)
	 Jacking aid temporarily deactivated.	Lift assistance temporarily deactivated (►►► 67)
 lights up yellow.	 Load equalisation failed.	Load compensation unavailable (►►► 67)
	 Tank reserve level reached.	Fuel down to reserve (►►► 68)
	 shows green.	Hill Start Control active (►►► 68)
	 flashes yellow.	Hill Start Control automatically deactivated (►►► 68)
	 is displayed.	Hill Start Control cannot be activated (►►► 69)

Indicator and warning lights	Display text	Meaning
	HSC not available. Engine not running.	Hill Start Control cannot be activated (►►► 69)
 lights up yellow.	 Cruise control has no function.	Cruise control failed (►►► 69)
 lights up yellow.	 ACC temporarily failed.	Distance control (Active Cruise Control ACC) temporarily failed (►►► 69)
 lights up yellow.	 Distance control failed.	Distance control (Active Cruise Control ACC) failed (►►► 69)
 lights up yellow.	 Front-collision warning temporarily failed.	Front collision warning temporarily unavailable (►►► 70)
 lights up yellow.	 Front-collision warning failed.	Front collision warning unavailable (►►► 70)
 lights up yellow.	 Lane change warning temporarily failed.	Lane change warning temporarily unavailable (►►► 70)
 lights up yellow.	 Lane change warning failed.	Lane change warning unavailable (►►► 71)
	 The gear indicator flashes.	Gear not taugth (►►► 71)

46 STATUS INDICATORS

Indicator and warning lights	Display text	Meaning
 flashes green.		Hazard warning lights system is switched on ( 72)
 flashes green.		
	 is displayed in white.	Service due ( 72)
	Service due!	
 lights up yellow.	 is displayed in yellow.	Service-due date has passed ( 72)
	Service overdue!	

Ambient temperature

The ambient temperature is displayed in the status line of the instrument cluster.

When the vehicle is at a standstill, the heat of the electrical machine can falsify the ambient-temperature reading. If the heat of the electrical machine is affecting it too much, dashes are temporarily shown in place of the value.



There is a risk of black ice if the ambient temperature falls below the limit value of approx. 3 °C.

The first time the temperature drops below this value, the ambient-temperature reading and the ice crystal symbol flash in the status line of the instrument cluster.

Outside temperature warning



is displayed.

Possible cause:

	<p>The air temperature measured at the vehicle is lower than:</p>
<p>approx. 3 °C</p>	



WARNING

Risk of black ice forming even when temperature is above approx. 3 °C

Risk of accident

- Always take extra care when temperatures are low; remember that there is particular danger of black ice forming on bridges and where the road is in shade.

- Ride carefully and think well ahead.

Radio-operated key out of range



lights up yellow.



Remote key not in range. Not possible to switch on ignition again.

Possible cause:

Communication between radio-operated key and engine electronics is disrupted.

- Check the battery in the radio-operated key.
- Replace the battery of the radio-operated key. (→ 95)
- Use the spare key to continue your journey.

48 STATUS INDICATORS

- Battery of the radio-operated key is empty or loss of the radio-operated key. (▶▶▶▶ 94)
- Remain calm if the Check Control dialogue appears on the display while you are riding. You can continue your journey, the engine will not switch off.
- Have the faulty radio-operated key replaced by an authorised BMW Motorrad retailer.

Keyless Ride failed

 lights up yellow.

 Keyless Ride failure. Do not stop the engine. It may not be possible to restart the engine.

Possible cause:

The Keyless Ride control unit has diagnosed a communication fault.

- Do not switch off the motor. Proceed as directly as possible to an authorised workshop, preferably an authorised BMW Motorrad retailer.
 - » Motor start with Keyless Ride can no longer be initiated.
 - » DWA can no longer be activated.

Replacing battery of radio-operated key

 lights up yellow.

 Remote key battery weak. Function limited. Change battery.

Possible cause:

- The integral battery in the radio-operated key has lost a significant proportion of its original capacity. There is no assurance of how long the radio-operated key can remain operational.
- Replace the battery of the radio-operated key. (▶▶▶▶ 95)

Voltage of the vehicle electrical system too low

 is displayed in yellow.

 Vehicle voltage low. Switch off unnecessary consumers.

The voltage of the vehicle electrical system is too low. If you continue to ride the motorcycle the on-board electronics will drain the battery.

Possible cause:

Consumers with high power consumption are in operation (such as heated body warmers), too many consumers are in operation at one time, or battery faulty.

- Switch off non-essential consumers or disconnect them from the vehicle's electrical system.
- If the fault persists or occurs without consumers connected, have the fault rectified as quickly as possible by a specialist workshop, preferably an authorised BMW Motorrad retailer.

Voltage of the vehicle electrical system critical



lights up yellow.



is displayed in yellow.



Vehicle voltage critical! Consumers were switched off. Check battery condition.



WARNING

Failure of the vehicle systems

Risk of accident

- Do not continue your journey.

The voltage of the vehicle electrical system is critical. The on-board electronics will drain the battery.

Possible cause:

Consumers with high power consumption are in operation (such as heated body warmers), too many consumers are in operation at one time, or battery faulty.

- Switch off non-essential consumers or disconnect them from the vehicle's electrical system.
- If the fault persists or occurs without consumers connected, have the fault rectified as quickly as possible by a specialist workshop, preferably an authorised BMW Motorrad retailer.

Charging voltage critical



flashes yellow.

50 STATUS INDICATORS

 is displayed in yellow.

 Battery voltage critical! Accident risk. Stop driving.

WARNING

Failure of the vehicle systems

Risk of accident

- Do not continue your journey.

Battery is not being charged. The on-board electronics will drain the battery.

Possible cause:

Alternator malfunction, battery faulty or fuse has blown.

- Have the fault rectified as quickly as possible by a specialist workshop, preferably an authorised BMW Motorrad retailer.

Fault in the vehicle battery

 lights up yellow.

 Fault in the on-board battery.

Limited onward journey possible. Drive carefully to nearest specialist workshop.

Possible cause:

Communication with the vehicle battery is disrupted.

- Have the fault rectified by a specialist workshop, preferably an authorised BMW Motorrad retailer.

Possible cause:

A battery type that does not match the encoding of the control unit has been installed.

- After a change of battery type, have the encoding checked by a specialist workshop, preferably an authorised BMW Motorrad retailer.

Vehicle battery overheated

 lights up yellow.

 On-board battery overheated. Switch off the engine or continue riding with restriction to allow cooling.

Possible cause:

The temperature sensor has detected a high temperature in the vehicle battery.

- If possible, ride in the part-load range to cool down the vehicle battery or shut down the engine.
- If the temperature in the vehicle battery is frequently

too high, have the fault rectified as soon as possible by a specialist workshop, preferably an authorised BMW Motorrad retailer.

Serious fault in the power supply

 flashes red.

 Serious fault in the power supply! Stop immediately! Have it checked by a specialist workshop.



WARNING

Failure of the vehicle systems

Risk of accident

- Do not continue your journey.

Possible cause:

The temperature sensor has detected a critical temperature in the vehicle battery or the vehicle voltage is too high. Engine shutdown is imminent.

- Stop the vehicle immediately.
- Have the fault rectified as quickly as possible by a specialist workshop, preferably an authorised BMW Motorrad retailer.

Bulb faulty

 lights up yellow.

 The faulty bulb is displayed:

 High beam faulty!

 Front left turn indicator faulty! or. Front right turn indicator faulty!

 Low-beam headlight faulty!

 Front side light faulty!

 Daytime riding light faulty!

–with additional headlight^{OE}

 Left additional headlight faulty! or. Right additional headlight faulty!<

 Tail light faulty!

 Brake light faulty!

 Rear left turn indicator faulty! or. Rear right turn indicator faulty!

 Number plate light faulty!

52 STATUS INDICATORS

–Have it checked by a specialist workshop.

 flashes yellow.

 The faulty bulb is displayed:

 Active headlight faulty.

WARNING

Vehicle overlooked in traffic due to failure of the lights on the vehicle

Safety risk

- Always replace a faulty bulb at the earliest possible opportunity. Consult a specialist workshop, preferably an authorised BMW Motorrad Retailer.

Possible cause:

One or more bulbs faulty.

- Identify faulty bulb or bulbs by visual check.
- Have LED light sources replaced as complete units; consult a specialist workshop, preferably an authorised BMW Motorrad retailer.

Light control failed

 lights up yellow.

 Light control failure! Have it checked by a specialist workshop.

WARNING

Vehicle overlooked in traffic on account of failure of the vehicle lighting

Safety risk

- Have the fault rectified as quickly as possible by a specialist workshop, preferably an authorised BMW Motorrad retailer.

The vehicle lighting has partially or completely failed.

Possible cause:

Light control has diagnosed a communication fault.

- Have the fault rectified as quickly as possible by a specialist workshop, preferably an authorised BMW Motorrad retailer.

Anti-theft alarm battery weak

–with anti-theft alarm (DWA)^{OE}

 Alarm system batt. capacity weak. No restrictions. Make an

appointment at a specialist workshop.

 This error message is displayed briefly only after the Pre-Ride-Check completes. Possible cause:

The integral battery in the anti-theft alarm has lost a significant proportion of its original capacity. There is no assurance of how long the anti-theft alarm can remain operational if the vehicle's battery is disconnected.

- Consult a specialist workshop, preferably an authorised BMW Motorrad retailer.

Anti-theft alarm battery flat

–with anti-theft alarm (DWA)^{OE}

 Alarm system battery empty. No independent alarm. Make an appointment at a specialist workshop.

 This error message is displayed briefly only after the Pre-Ride-Check completes.

Possible cause:

The integral battery in the anti-theft alarm (DWA) has lost its entire original capacity. The system cannot guarantee the DWA function if the vehicle battery is disconnected.

- Consult a specialist workshop, preferably an authorised BMW Motorrad retailer.

DWA failed

–with anti-theft alarm (DWA)^{OE}

 Alarm system failure
Have it checked by a specialist workshop.

Possible cause:

The DWA control unit has diagnosed a communication fault.

- Consult a specialist workshop, preferably an authorised BMW Motorrad retailer.
- » DWA can no longer be activated or deactivated.
- » False alarm possible.

Electronic oil-level check

 The electronic oil-level check assesses the oil level in the engine as OK or Low!

The following preconditions have to be satisfied for electronic oil-level checking, and several measurements might have to be taken:

- Engine idling for at least 20 seconds.
- Engine is at operating temperature.
- Vehicle is standing upright on a smooth, level surface.

54 STATUS INDICATORS

- Side stand has been retracted.
- without Dynamic Suspension Adjustment^{OE}
- The suspension strut is set to suit the load state.

If measurement is incomplete or if these conditions are not met, the oil level cannot be judged by the system. Dashes (---) appear on the display instead of a reading.

Engine-oil level too low

 lights up yellow.

 Engine oil level
Check engine oil level.

Possible cause:

The electronic oil-level sensor has registered a low oil level. If the vehicle is not standing upright on a smooth, level surface, the message might appear even though the oil level is correct. The next time you stop for fuel:

- Check the engine oil level.
( 202)

If the oil level in the sight glass is too low:

- Topping up the engine oil.
( 204)

When the oil level in the sight glass is correct:

- Check whether the preconditions for the electronic oil-level check are met.

If the message appears repeatedly, even though the oil level is slightly below the **MAX** mark:

- Consult a specialist workshop, preferably an authorised BMW Motorrad retailer.

Engine temperature high

 lights up yellow.

 Engine temp. high!
Continue riding with restriction to allow cooling.

ATTENTION

Riding with overheated engine

Engine damage

- Compliance with the information set out below is essential.

Possible cause:

The coolant level is too low.

- Check the coolant level.
( 209)

If the coolant level is too low:

- Allow the motor to cool down. Top up the coolant. Have the cooling system checked by a specialist

workshop, preferably an authorised BMW Motorrad retailer.

Possible cause:

The temperature sensor has detected a high temperature in the motor.

- If possible, ride in the part-load range to cool down the motor.
- If the motor temperature is frequently too high, have the fault rectified as soon as possible by a specialist workshop, preferably an authorised BMW Motorrad retailer.

Engine overheated



lights up red.



Engine overheating!
Stop when it is safe to do so and switch off the engine.



ATTENTION

Riding with overheated engine

Engine damage

- Compliance with the information set out below is essential.

Possible cause:

The coolant level is too low.

- Check the coolant level. (▮▮▮▮▶ 209)

If the coolant level is too low:

- Allow the motor to cool down. Top up the coolant. Have the cooling system checked by a specialist workshop, preferably an authorised BMW Motorrad retailer.

Possible cause:

Engine is overheated.

- Carefully bring the vehicle to a stop, switch off the engine and wait until the engine has cooled down.
- If engine overheating is a frequent occurrence, have the fault rectified as quickly as possible by a specialist workshop, preferably an authorised BMW Motorrad retailer.

Drive malfunction



shows.



Engine! Have it checked by a specialist workshop.

56 STATUS INDICATORS

Possible cause:

The motor control unit has diagnosed a fault that affects pollutant emissions and/or reduces power.

- Have the fault rectified by a specialist workshop, preferably an authorised BMW Motorrad retailer.
- » You can continue riding; pollutant emissions are higher than the threshold values.

Serious drive malfunction



flashes red.



flashes.



Serious fault in the engine control! Riding at mod. speed pos. Damage possible. Have checked by workshop.

Possible cause:

The engine control unit has diagnosed a fault that can lead to damage to the exhaust system.

- Have the fault rectified as quickly as possible by a specialist workshop, preferably an authorised BMW Motorrad retailer.

» It is possible to continue to ride but not recommended.

Engine control failed



lights up yellow.



shows.



No communication with engine control. Multiple sys. affected. Ride carefully to the next specialist workshop.

Possible cause:

Communication with the engine control unit has failed.

- Have the fault rectified as quickly as possible by a specialist workshop, preferably an authorised BMW Motorrad retailer.

Engine in emergency-operation mode



lights up yellow.



Fault in the engine control. Onward journey possible. Ride carefully to next specialist workshop.

**WARNING****Unusual ride characteristics when engine running in emergency-operation mode**

Risk of accident

- Avoid accelerating sharply and overtaking.

Possible cause:

The electronic control unit has diagnosed a fault. In exceptional cases, the engine stops and refuses to start. Otherwise, the engine runs in emergency operating mode.

- You can continue to ride, but bear in mind that the usual engine performance might not be available.
- Have the fault rectified as quickly as possible by a specialist workshop, preferably an authorised BMW Motorrad retailer.

Serious fault in engine control

flashes red.



Serious fault in the engine control! Riding at mod. speed pos. Damage possible. Have checked by workshop.

**WARNING****Engine damage when running in emergency-operation mode**

Risk of accident

- Ride slowly, avoid accelerating sharply and overtaking.
- If possible, have the vehicle picked up and have the fault rectified by a specialist workshop, preferably an authorised BMW Motorrad Retailer.

Possible cause:

The engine control unit has diagnosed a fault that can lead to serious consequential faults. The engine is in emergency-operation mode.

- It is possible to continue to ride but not recommended.
- Avoid high load and rpm ranges if possible.
- Have the fault rectified as quickly as possible by a specialist workshop, preferably an authorised BMW Motorrad retailer.

Tyre pressure close to limit of permitted tolerance

lights up yellow.

58 STATUS INDICATORS

 is displayed in yellow.

 Tyre pressure does not match setpoint
Check tyre pressure.

Possible cause:

Measured tyre pressure is close to the limit of permitted tolerance.

- Correct tyre pressure.
- Before adjusting tyre pressure, read the information on temperature compensation and adjusting pressure in the section entitled "Engineering details":

» Temperature compensation (➡ 191)

» Pressure adaptation (➡ 192)

» Find the correct tyre pressures in the following places:

- Back cover of the rider's manual
- Instrument cluster in the **TYRE PRESSURE** view
- Tyre pressures table

Tyre pressure outside permitted tolerance

 flashes red.

 is displayed in red.

 Tyre pressure does not match setpoint

Stop immediately! Check tyre pressure.

 Tyre press. control.
Loss of pressure.
Stop immediately! Check tyre pressure.

WARNING

Tyre pressure outside the permitted tolerance.

Risk of accident, degradation of the vehicle's driving characteristics.

- Adapt your style of riding accordingly.

Possible cause:

Measured tyre pressure is outside permitted tolerance.

- Check the tyre for damage and to ascertain whether the vehicle can be ridden with the tyre in its present condition.

If the vehicle can be ridden with the tyre in its present condition:

- Correct the tyre pressure at the earliest possible opportunity.
- Before adjusting tyre pressure, read the information on temperature compensation and adjusting pressure in the section entitled "Engineering details":

- » Temperature compensation (▣▣▣▶ 191)
- » Pressure adaptation (▣▣▣▶ 192)
- » Find the correct tyre pressures in the following places:
 - Back cover of the rider's manual
 - Instrument cluster in the TYRE PRESSURE view
 - Tyre pressures table
- Have the tyre checked for damage by a specialist workshop, preferably an authorised BMW Motorrad retailer.

If you are unsure whether the vehicle can be ridden with the tyre in its present condition:

- Do not continue your journey.
- Notify the breakdown service.

Transmission fault



"----"

Possible cause:

The vehicle has not reached the minimum speed (▣▣▣▶ 190).



RDC sensor is not active

min 30 km/h (The RDC sensor does not transmit its signal to the vehicle until a certain minimum speed has been reached.)

- Increase speed above this threshold and observe the RDC readings. Assume that

a permanent fault has not occurred unless the 'General' warning light comes on to accompany the symptoms. Under these circumstances:

- Have the fault rectified by a specialist workshop, preferably an authorised BMW Motorrad retailer.

Possible cause:

Wireless communication with the RDC sensors has been disrupted. Possible causes include radio-communication systems operating in the vicinity and interfering with the link between the RDC control unit and the sensors.

- Move to another location and observe the RDC readings. Assume that a permanent fault has not occurred unless the 'General' warning light comes on to accompany the symptoms. Under these circumstances:
- Have the fault rectified by a specialist workshop, preferably an authorised BMW Motorrad retailer.

Sensor faulty or system fault



lights up yellow.

60 STATUS INDICATORS



"----"

Possible cause:

Vehicle is fitted with wheels not equipped with RDC sensors.

- Retrofit a set of wheels equipped with RDC sensors.

Possible cause:

One or both RDC sensors have failed or a system fault has occurred.

- Have the fault rectified by a specialist workshop, preferably an authorised BMW Motorrad retailer.

Tyre pressure monitoring (RDC) failed



lights up yellow.



Tyre pressure check failure! Function limited. Have it checked by a specialist workshop.

Possible cause:

The tyre pressure control (RDC) control unit has diagnosed a communication fault.

- Consult a specialist workshop, preferably an authorised BMW Motorrad retailer.

» Tyre pressure warnings not available.

Battery for tyre pressure sensor weak



lights up yellow.



RDC sensor battery weak. Function limited. Have it checked by a specialist workshop.



This error message is displayed briefly only after the Pre-Ride-Check completes.

Possible cause:

The integral battery in the tyre pressure sensor has lost a significant proportion of its original capacity. There is no assurance of how long the tyre pressure monitoring system can remain operational.

- Consult a specialist workshop, preferably an authorised BMW Motorrad retailer.

Malfunction, drop sensor



Drop sensor faulty. Have it checked by a specialist workshop.

Possible cause:

The drop sensor is not available.

- Consult a specialist workshop, preferably an authorised BMW Motorrad retailer.

Motorcycle dropped

 Cannot start engine. Stand motorcycle upright. Switch ignition on/off. Start the engine.

Possible cause:

The drop sensor has detected a drop and has cut out the engine.

- Hold the vehicle upright and check it for damage.
- Switch the ignition off and then on again or switch the kill switch on and then off again.

Emergency call function restricted

—with intelligent emergency call^{OE}

 lights up yellow.

 Emergency call system restricted. If this occurs again, have the vehicle checked by a specialist workshop.

Possible cause:

The emergency call cannot be made automatically or cannot be made via BMW.

- Consult the information on operating the intelligent emergency call on page (➔ 97)

- Consult a specialist workshop, preferably an authorised BMW Motorrad retailer.

Emergency call function failed

—with intelligent emergency call^{OE}

 lights up yellow.

 Emergency call system error. Make an appointment at a specialist workshop.

Possible cause:

The control unit of the emergency call system has diagnosed a fault. The emergency call function has failed.

- Bear in mind that an emergency call cannot be made.
- Consult a specialist workshop, preferably an authorised BMW Motorrad retailer.

Malfunction, side stand monitor

 lights up yellow.

 Side stand monitoring faulty. Onward journey possible. Engine will stop if stationary! Have checked by workshop.

62 STATUS INDICATORS

Possible cause:



Side-stand switch or wiring damaged

The engine will switch off when speed drops below the minimum threshold. You cannot resume your journey.

min 5 km/h

- Consult a specialist workshop, preferably an authorised BMW Motorrad retailer.

ABS self-diagnosis not completed



flashes.

Possible cause:



ABS self-diagnosis not completed

The ABS function is not available, because self-diagnosis did not complete. (The motorcycle has to reach a defined minimum speed with the engine running for the wheel sensors to be checked: min 5 km/h)

- Pull away slowly. Bear in mind that the ABS function is not available until self-diagnosis has completed.

ABS fault



lights up yellow.



shows.



Limited ABS availability! Onward journey possible. Ride carefully to next specialist workshop.

Possible cause:

The ABS control unit has detected a fault. The ABS function is available, subject to restrictions.

- You can continue to ride. Bear in mind the more detailed information on certain situations that can lead to an ABS fault message (174).
- Have the fault rectified as quickly as possible by a specialist workshop, preferably an authorised BMW Motorrad retailer.

ABS failed



lights up yellow.



shows.



ABS failure! Onward journey possible.

Ride carefully to next specialist workshop.

Possible cause:

The ABS control unit has detected a fault. The ABS function is not available.

- You can continue to ride.
Bear in mind the more detailed information on certain situations that can lead to an ABS fault message (▮▮▮▮▶ 174).
- Have the fault rectified as quickly as possible by a specialist workshop, preferably an authorised BMW Motorrad retailer.

ABS Pro failed



lights up yellow.



shows.



ABS Pro failure! Onward journey possible. Ride carefully to next specialist workshop.

Possible cause:

Monitoring of the ABS Pro function has detected a fault. The ABS Pro function is not available. The ABS function is still available. ABS provides support only for braking in straight-ahead driving.

- You can continue to ride.
Bear in mind the more detailed information on certain situations that can lead to an ABS Pro fault message (▮▮▮▮▶ 174).
- Have the fault rectified as quickly as possible by a specialist workshop, preferably an authorised BMW Motorrad retailer.

ABS control at front wheel only

–with riding modes Pro^{OE}



flashes irregularly.

Possible cause:

ABS control for the rear wheel is switched off in the currently selected riding mode. The rear wheel brake can lock the rear wheel.

- Check the settings of the riding mode.
- For more information on setting up the riding modes, see the section entitled "Engineering details" (▮▮▮▮▶ 185).

DTC intervention



quick-flashes.

64 STATUS INDICATORS

Possible cause:

The DTC has detected a degree of instability at the rear wheel and has intervened to reduce torque.

The indicator and warning light flashes longer than the duration of the DTC. This affords the rider visual feedback on control intervention even after the critical situation has been dealt with.

- You can continue to ride. Ride carefully and think well ahead.

DTC self-diagnosis not completed

 slow-flashes.

Possible cause:

 DTC self-diagnosis not completed

The DTC function is not available, because self-diagnosis did not complete. (The motorcycle has to reach a defined minimum speed with the engine running for the wheel sensors to be checked: min 5 km/h)

- Pull away slowly. Bear in mind that the DTC function is not available until self-diagnosis has completed.

DTC switched off

 shows.

 Off!

 Traction control deactivated.

Possible cause:

The rider has switched off the DTC system.

- Operate the DTC. (►► 103)

DTC restricted

 lights up yellow.

 shows.

 Traction control limited! Onward journey possible.

Ride carefully to next specialist workshop.

Possible cause:

The engine control unit has detected a DTC fault.

- Bear in mind that the DTC function and other dynamic control system functions are restricted.
- You can continue to ride. Bear in mind the more detailed information on situations that can lead to a DTC fault (►► 177).

- Have the fault rectified as quickly as possible by a specialist workshop, preferably an authorised BMW Motorrad retailer.

DTC fault

 lights up yellow.

 shows.

 Traction control failure! Onward journey possible.

Ride carefully to next specialist workshop.

Possible cause:

The engine control unit has detected a DTC fault.

- Bear in mind that the DTC function and other dynamic control system functions are not available.
- You can continue to ride. Bear in mind the more detailed information on situations that can lead to a DTC fault (► 177).
- Have the fault rectified as quickly as possible by a specialist workshop, preferably an authorised BMW Motorrad retailer.

DSA fault, damping adjustment

–with Dynamic Suspension Adjustment^{OE}

 lights up yellow.

 Damping adjustment failed. Limited onward journey possible. Drive carefully to nearest specialist workshop.

Possible cause:

Components of the electronic damping adjustment system are faulty or communication with the control unit is disrupted. In this condition, the motorcycle has too much damping and is uncomfortable to drive, especially on roads in poor condition.

- Bear in mind that damping adjustment is not available.
- Have the fault rectified as quickly as possible by a specialist workshop, preferably an authorised BMW Motorrad retailer.

66 STATUS INDICATORS

DSA fault, suspension adjustment limited

—with Dynamic Suspension Adjustment^{OE}

 lights up yellow.

 Suspension adjustment limited. Onward journey possible. Have it checked by a specialist workshop.

Possible cause:

Components of the electronic suspension adjustment system are faulty or communication with the control unit is disrupted.

- Bear in mind that damping adjustment and ride height adjustment are not available or availability is restricted.
- Have the fault rectified as quickly as possible by a specialist workshop, preferably an authorised BMW Motorrad retailer.

DSA fault, suspension adjustment unavailable

—with Dynamic Suspension Adjustment^{OE}

 lights up yellow.

 Suspension adjustment failed. Limited onward journey possible. Drive carefully to nearest specialist workshop.

Possible cause:

Components of the electronic suspension adjustment system are faulty or communication with the control unit is disrupted.

- Bear in mind that damping adjustment and ride height adjustment are not available.
- Have the fault rectified as quickly as possible by a specialist workshop, preferably an authorised BMW Motorrad retailer.

DSA fault, lowering suspension

—with Adaptive Ride Height^{OE}

 lights up yellow.

 Ride height. Lowering not possible. Stop carefully. Have it checked by a specialist workshop.

Possible cause:

Components of the electronic suspension adjustment system are faulty or communication with the control unit is disrupted.

- Bear in mind that ride height cannot be lowered.
- You can continue to ride. Bear the raised seat position in mind when pulling away.
- Have the fault rectified as quickly as possible by a specialist workshop, preferably an authorised BMW Motorrad retailer.

DSA fault, raising suspension

–with Adaptive Ride Height^{OE}



lights up yellow.



Ride height. Raising not possible. Take care when banking. Have it checked by a specialist workshop.

Possible cause:

Components of the electronic suspension adjustment system are faulty or communication with the control unit is disrupted.

- Bear in mind that ride height cannot be raised.
- You can continue to ride. Think well ahead when riding

and avoid banking at steep angles.

- Have the fault rectified as quickly as possible by a specialist workshop, preferably an authorised BMW Motorrad retailer.

Lift assistance temporarily deactivated

–with Adaptive Ride Height^{OE}



Jacking aid temporarily deactivated.

Too frequent activation can cause damage. Switch ignition off/on.

Possible cause:

The lift assistance function was used several times in succession.

- Avoid repeated actuation of the lift assistance function so as to avoid draining the battery.
- Before using the lift assistance function again, switch the ignition off and on again.

Load compensation unavailable

–with Dynamic Suspension Adjustment^{OE}



lights up yellow.

68 STATUS INDICATORS

 Load equalisation failed. Observe ride position. Have it checked by a specialist workshop

Possible cause:

Components of the electronic suspension adjustment system are faulty or communication with the control unit is disrupted. A lack of ride comfort might be perceptible, particularly if the road is in poor condition.

- Bear in mind that load equalisation is not available.
- Have the fault rectified as quickly as possible by a specialist workshop, preferably an authorised BMW Motorrad retailer.

Fuel down to reserve

 Tank reserve level reached. Ride to the next filling station.



WARNING

Irregular engine operation or engine shutdown due to lack of fuel

Risk of accident, damage to catalytic converter

- Do not run the fuel tank dry.

Possible cause:

The fuel tank contains no more than the reserve quantity of fuel.



Reserve fuel

approx. 4 l

- Refuel. (▶▶▶ 164)

Hill Start Control active

 shows green.

Possible cause:

Hill Start Control (▶▶▶ 193) has been activated by the rider.

- Switch off Hill Start Control.
- Operate Hill Start Control. (▶▶▶ 122)

Hill Start Control automatically deactivated

 flashes yellow.

Possible cause:

Hill Start Control has been automatically deactivated.

- Side stand has been extended.
 - » Hill Start Control is deactivated when the side stand is extended.
- Engine has been switched off.
 - » Hill Start Control is deactivated when the engine is switched off.

- Operate Hill Start Control.
( 122)

Hill Start Control cannot be activated



is displayed.

HSC not available. Engine not running.

Possible cause:

Hill Start Control cannot be activated.

- Retract the side stand.
» Hill Start Control is operational only with the side stand retracted.
- Start the engine.
» Hill Start Control is operational only while the engine is running.

Cruise control failed



lights up yellow.



Cruise control has no function. Onward journey possible. Inspection at workshop required.

Possible cause:

The control unit has detected a fault.

- Bear in mind that the cruise control function is not available.
- You can continue to ride. Have the fault rectified as

quickly as possible by a specialist workshop, preferably an authorised BMW Motorrad retailer.

Distance control (Active Cruise Control ACC) temporarily failed

—with Riding Assistant^{OE}



lights up yellow.



ACC temporarily failed. Check front radar sensor for damage.

Possible cause:

The function of the front radar sensor is impaired.

- Bear in mind that the distance control function (ACC) is temporarily not available. Adaptive cruise control is still available.
- You can continue to ride. Check the front radar sensor. Remove dirt or objects obstructing the radar sensor.
- Comply with the care and cleaning instructions ( 256).

Distance control (Active Cruise Control ACC) failed

—with Riding Assistant^{OE}



lights up yellow.

70 STATUS INDICATORS

 Distance control failed. Have it checked by a specialist workshop.

Possible cause:

The control unit has detected a fault.

- Bear in mind that the distance control function (ACC) is not available. Adaptive cruise control is still available.
- You can continue to ride. Have the fault rectified as quickly as possible by a specialist workshop, preferably an authorised BMW Motorrad retailer.

Front collision warning temporarily unavailable

—with Riding Assistant^{OE}

 lights up yellow.

 Front-collision warning temporarily failed. Check front radar sensor for damage.

Possible cause:

The function of the front radar sensor is impaired.

- Bear in mind that the front collision warning function is temporarily not available.
- You can continue to ride. Check the front radar sensor.

- Remove dirt or objects obstructing the radar sensor.
- Comply with the care and cleaning instructions (➡ 256).

Front collision warning unavailable

—with Riding Assistant^{OE}

 lights up yellow.

 Front-collision warning failed. Have it checked by a specialist workshop.

Possible cause:

The control unit has detected a fault.

- Bear in mind that the front collision warning function is not available.
- You can continue to ride. Have the fault rectified as quickly as possible by a specialist workshop, preferably an authorised BMW Motorrad retailer.

Lane change warning temporarily unavailable

—with Riding Assistant^{OE}

 lights up yellow.

 Lane change warning temporarily failed. Onward journey possible.

Check radar sensor for damage.

Possible cause:

The function of the rear radar sensor is impaired.

- Bear in mind that the lane change warning function is temporarily not available.
- You can continue to ride. Check the rear radar sensor. Remove dirt or objects obstructing the radar sensor.
- Comply with the care and cleaning instructions (▶▶ 256).

Lane change warning unavailable

–with Riding Assistant^{OE}



lights up yellow.



Lane change warning failed. Onward journey possible. Inspection at specialist workshop required.

Possible cause:

The control unit has detected a fault.

- Bear in mind that the lane change warning function is not available.
- You can continue to ride. Have the fault rectified as quickly as possible by a specialist workshop, preferably

an authorised BMW Motorrad retailer.

Gear not taught

–with shift assistant Pro^{OE}



The gear indicator flashes.

Possible cause:

The gearbox sensor is not fully trained.

- Start the engine. (▶▶ 152)
- Select neutral N.
- Extend and then retract the side stand, without touching the shift lever.
- Use clutch control to engage each gear in turn. In each gear repeatedly move the throttle twistgrip to the idle position and then re-open the throttle.
- » The gear indicator stops flashing when the gearbox sensor has been trained successfully.
- When the gearbox sensor has been taught successfully, Gear Shift Assistant Pro works as described (▶▶ 192).
- If teaching is not successful, have the fault rectified by a specialist workshop, preferably an authorised BMW Motorrad retailer.

72 STATUS INDICATORS

Hazard warning lights system is switched on



flashes green.



flashes green.

Possible cause:

The driver has switched on the hazard warning lights system.

- Operate the hazard warning flashers. (→ 102)

Service display



If service is overdue, the due date or the odometer reading at which service was due is accompanied by the general warning light showing yellow.

If the service is overdue, a yellow Check Control message is displayed. Exclamation marks also draw your attention to the displays for service, service appointment and countdown distance in the MY VEHICLE and SERVICE REQUIREMENTS menu screens.



If the service-due indicator appears more than a month before the service date, the current date has to be corrected. This situation can occur if the battery was disconnected.

Service due



is displayed in white.

Service due! Have service performed by a specialist workshop.

Possible cause:

Service is due, because of either distance covered or time expired.

- Have your vehicle serviced regularly by a specialist workshop, preferably an authorised BMW Motorrad retailer.
- » The vehicle remains operationally reliable and road-worthy.
- » The vehicle retains its value.

Service-due date has passed



lights up yellow.



is displayed in yellow.

Service overdue! Have service performed by a specialist workshop.

Possible cause:

Service is overdue because of the driving performance or the date.

- Have your vehicle serviced regularly by a specialist workshop, preferably an authorised BMW Motorrad retailer.

- » The vehicle remains operationally reliable and road-worthy.
- » The vehicle retains its value.

INSTRUMENT CLUSTER

04

WARNINGS	76
CONTROLS	76
MULTI-FUNCTION ROCKER SWITCH	77
MENUS	79
MY VEHICLE	80
SETTINGS	81
BLUETOOTH PAIRING	82
OPERATING FOCUS	84
NAVIGATION	85
MEDIA	87
TELEPHONE	88
SOFTWARE VERSION	88
LICENCE INFORMATION	88

76 INSTRUMENT CLUSTER

WARNINGS



WARNING

Operation of a smartphone while riding the vehicle

Risk of accident

- Always comply with the road traffic regulations in force where you are riding.
- Do not use a smartphone while riding. This applies with the exception of applications without operation, such as hands-free telephony.



WARNING

Distraction from the road and loss of control

Operating the integrated information system and communication devices while driving results in a risk of accident

- Operate those systems or devices only when the traffic situation allows for it.
- If necessary, stop and operate the systems or devices when stationary.

CONTROLS

Multi-Controller

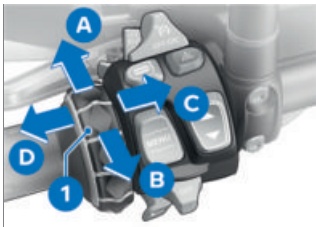

- 1** Multi-Controller
- A** Move the cursor up in lists
Increase volume
- B** Move the cursor down in lists
Reducing volume
- C** Activate function in accordance with feedback
Confirm selection/setting
Scrolling through menu screens
- D** Activate function in accordance with feedback or go back
Return to Menu view after making settings
Change up one level in the hierarchy
Scrolling through menu screens

MENU rocker button



Short-press the top section of MENU rocker button 1:

- In Menu view: Change up one level.
- In Pure Ride view: Change the display for rider info. status line.

Long-press the top section of MENU rocker button 1:

- In Menu view: Open the Pure Ride view.
- In Pure Ride or Sport view: Switch the operating focus to the Navigator.

Short-press the bottom section of MENU rocker button 1:

- Change down a level.
- Confirm selection/setting.

Long-press the bottom section of MENU rocker button 1:

- Change back to the last menu after a previous menu change effected by long-pressing the

top section of the rocker button.

 Instructions given by the navigation system are displayed as a dialogue if the Navigation menu has not been called up. Operation of the MENU rocker button is temporarily restricted.

MULTI-FUNCTION ROCKER SWITCH

Principle

The multi-function rocker switch enables operation of individually assigned functions. In the MULTI-ROCKER SWITCH menu one function can be assigned and a second function selected as the priority-select function. Settings made by means of the multi-function rocker switch are retained after the ignition has been switched off.

78 INSTRUMENT CLUSTER

Assigning function



- Press button **1**.
» The **MULTI-ROCKER SWITCH** menu opens.
- Use Multi-Controller **3** to select the desired function.
- Short-push Multi-Controller **3** to the right.

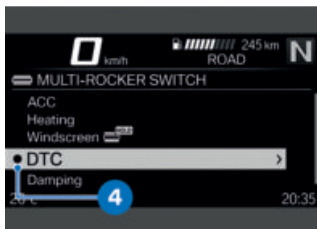

Function **4** is assigned to the multi-function rocker switch.

- Use multi-function rocker switch **2** to set the value for the function.

 The current status of the function is shown the first time the button is pressed. Pressing the button a second time changes function value.

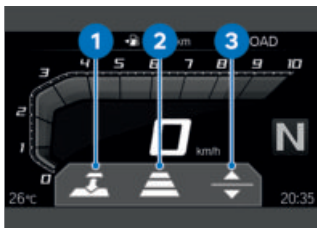

Operating feedback shows the symbol of the corresponding function **1** and the status of the function **2**. The arrows **3** show the corresponding setting options.

Priority-select function

The priority-select function provides a way of toggling temporarily between the assigned function and one other function.

Selecting priority-select function



- Press button **1**.
» The **MULTI-ROCKER SWITCH** menu opens.

- Use Multi-Controller **2** to select the desired function.
- Long-push Multi-Controller **2** to the right.

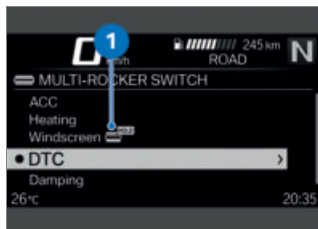

Symbol **1** indicates that the function is selected as the priority-select function.

Using priority select Requirement

In the MULTI-ROCKER SWITCH menu, the currently assigned function is distinguished from the priority-select function.



- Long-press button **1**.

- » The operating feedback for the priority-select function is shown.
- While the operating feedback is visible, press multi-function rocker switch **2** to change the value for the priority-select function.

 After the operating feedback disappears, the assignment of the multi-function rocker switch resets to the currently selected function.

MENUS

Requirement

Pure Ride view is displayed.

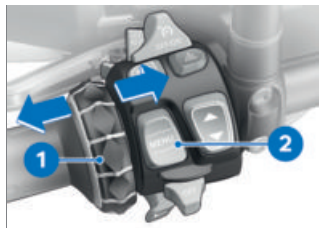

- Long-press the top section of MENU rocker button **2** to open the Pure Ride view.
- Short-press the bottom section of MENU rocker button **2**.
- Repeatedly short-push Multi-Controller **1** to the right until the menu item you want is highlighted.

80 INSTRUMENT CLUSTER

- Short-press the bottom section of MENU rocker button 2 to open the corresponding menu.

MY VEHICLE

Call up the on-board computer

- Call up the My vehicle menu.
- Scroll to the right until the ON-BOARD COMPUTER menu screen is displayed.

Reset the on-board computer

- Call up the My vehicle menu.
- Call up the ON-BOARD COMPUTER menu screen.
- Press the bottom section of the MENU rocker button.
- Select *Reset all values* or *Reset individual values* and confirm.
- Alternatively: Change to Pure Ride view.
- Repeatedly short-press the top section of rocker button MENU to select the value in the top status line.
- Long-press the top section of rocker button MENU to reset the selected value.

The following values can be reset:



Break



Journey



Current



Speed



Consump.

Call up the trip computer

- Call up the on-board computer. (▶▶▶▶ 80)
- Scroll to the right until the TRIP COMPUTER menu screen is displayed.

Reset the trip computer

- Call up the My vehicle menu.
- Call up the TRIP COMPUTER menu screen.
- Press the bottom section of the MENU rocker button.
- Select *Autom. reset* or *Reset all values* and confirm.
- » If *Autom. reset* is selected, the trip computer is automatically reset when a minimum of 6 hours have passed and the date has changed since the ignition was switched off.

SETTINGS

Select the content of the top status line

Requirement

The vehicle is at a standstill.

- Change to Pure Ride view.
 - » The instrument cluster shows all the information necessary for riding on public roads from the on-board computer (e.g. TRIP 1) and the trip computer (e.g. TRIP 2). The information can be displayed in the top status line.
- Navigate to Settings, Display, Status line content.
- Switch on the desired displays.
 - » You can switch between the selected displays in the top status line. If no displays are selected, only the range will be displayed.

Changing display in top status line

- Select the content of the top status line. (▮▮▮▮▶ 81)



- Change to Pure Ride view.
- Repeatedly short-press button **1** to select the value in the top status line **2**.

The following values can be displayed:

- Total distance
- Current distance 1
- Current distance 2
- Consumption 1 (Average)
- Consumption 2 (Average)
- Riding time 1
- Riding time 2
- Break 1
- Break 2

82 INSTRUMENT CLUSTER

 Speed 1 (Average)

 Speed 2 (Average)

 Tyre pressure

 Fuel tank level

 Range

Adjusting volume

- Connect the rider's and passenger's helmets. (▶▶▶ 83)
- Increase volume: Turn the Multi-Controller up.
- Reduce volume: Turn the Multi-Controller down.
- Mute: Turn the Multi-Controller all the way down.

Changing system settings

- Navigate to Settings, System settings.
- » You can change the following system settings here:
 - Date and time
 - Units
 - Language

Adjusting brightness

- Navigate to Settings, Display, Brightness.
- Adjust display brightness.
- » When ambient brightness drops below a defined threshold, the display is

dimmed to the brightness set here.

Reset all settings

- Call up the Settings menu.
- Select Reset all and confirm.

The settings in the following menus are reset to their default factory settings:

- Vehicle settings
- System settings
- Connections
- Display
- Information

- » Existing Bluetooth connections are not deleted.
- » The pairing of the vehicle to the current BMW Motorrad Connected-Ride account is reset.

BLUETOOTH PAIRING

Pairing

Two Bluetooth devices have to recognise each other before they can communicate. This process of mutual recognition is known as pairing. When two devices have paired they remember each other, so the pairing process is conducted only once, on initial contact.

 On some mobile devices, e.g. those with the iOS operating system, the

BMW Motorrad Connected app has to be opened prior to use.

During the pairing process, the instrument cluster searches for other Bluetooth-compatible devices within its reception range. The conditions that have to be satisfied before the audio system can recognise another device are as follows:

- The device's Bluetooth function must be active
- The device must be "visible" to others
- Other Bluetooth-compatible devices must be OFF (e.g. mobile phones and navigation systems).

Please consult the operating instructions for your communication system.

Pairing

- Navigate to **Settings, Connections**.
- » Bluetooth connections can be established, managed and deleted in the **CONNECTIONS** menu. The following Bluetooth connections are displayed:
 - Mobile device
 - Rider's helmet
 - Passenger helm.

The connection status for mobile devices is displayed.

Connect mobile device

- Perform pairing. (▶▶▶ 83)
- Activate the mobile device's Bluetooth function (see mobile device's operating instructions).
- Select **Mobile device** and confirm.
- Select **Pair new mobile device** and confirm.

Mobile devices are being searched for.



flashes in the bottom status line during pairing.

Mobile devices found are displayed.

- Select and confirm mobile device.
- Follow the instructions on the mobile device.
- Confirm that the code matches.
- » The connection is established and the connection status updated.
- » If the connection is not established, consult the troubleshooting chart in the section entitled "Technical data". (▶▶▶ 262)

Connect rider's and passenger's helmet

- Perform pairing. (▶▶▶ 83)

84 INSTRUMENT CLUSTER

- Select Rider's helmet or Passenger helm. and confirm.
- Make the helmet's communication system visible.
- Select Pair new rider's helmet or Pair new passenger helmet and confirm. Helmets are searched for.

 flashes in the bottom status line during pairing.

Helmets found are displayed.

- Select and confirm helmet.
- » The connection is established and the connection status updated.
- » If the connection is not established, consult the troubleshooting chart in the section entitled "Technical data". (➡ 262)

Delete connections

- Navigate to Settings, Connections.
- Select Delete connections.
- To delete an individual connection, select the connection and confirm.
- To delete all connections, select Delete all connections and confirm.

OPERATING FOCUS

–with preparation for navigation system^{OE}

Change of operating focus

If the Navigator is connected, you can toggle between operation of the Navigator and operation of the instrument cluster.

Change the operating focus

- Secure the navigation device. (➡ 249)
- Long-press the top section of the MENU rocker button.
- » Dialog menu and progress indicator are shown.

The following selection is possible:

- Navigator operation
- Show Pure Ride

In Pure Ride view:

- Navigator operation
- Reset OBC values
- Press and hold down the top section of rocker button MENU until the progress indicator reaches maximum, or confirm Navigator operation.
- » Operating focus changes to the Navigator.
- » Operating navigation system (➡ 250)
- To change the operating focus to the instrument cluster,

short-press the bottom section of rocker button MENU.

NAVIGATION

Precondition

The vehicle is connected via Bluetooth to a compatible mobile device.

The BMW Motorrad Connected app is installed on the connected mobile device.

 On some mobile devices, e.g. those with the iOS operating system, the BMW Motorrad Connected app has to be opened prior to use.

Enter the destination address

- Connect a mobile device. (▶▶▶▶ 83)
- Call up the BMW Motorrad Connected app and start the route guidance.
- Call up the *Navigation* menu.
 - » Active route guidance is displayed.
 - » If active route guidance is not displayed, consult the troubleshooting chart in the section entitled "Technical data". (▶▶▶▶ 263)

Select destination from recent destinations

- Navigate to *Navigation*, *Recent destinations*.
- Select and confirm destination.
- Select *Start route guidance*.

Select destination from favourites

- The *FAVOURITES* menu shows all the destinations saved as favourites in the BMW Motorrad Connected app. You cannot use the instrument cluster to add favourites to the list.
- Navigate to *Navigation*, *Favourites*.
- Select and confirm destination.
- Select *Start guidance*.

Enter special destinations

- Navigate to *Navigation*, *POIs*.

The following locations can be selected:

- At current location
- At destination
- Along the route
- Select where the special destinations should be looked for. For example, the following special destination can be selected:
 - Filling station

86 INSTRUMENT CLUSTER

- Select and confirm the special destination.
- Select Start route guidance and confirm.

Set route criteria

- Navigate to Navigation, Route criteria.

The following criteria can be selected:

- Route type
- Avoid
- Select desired Route type.
- Switch desired Avoid on or off.

The number of avoidances activated is displayed in brackets.

View the route information

- Navigate to Navigation, Settings and select Route info.

You can choose between the following options:

- Dest.
- Waypoint
- Select the desired option.
- » Countdown distance and time are displayed.

Edit route guidance

- Navigate to Navigation, New destination.

You can choose from the following destinations:

- Recent destinations
- Favourites
- POIs

- Select a destination from one of the three destination categories.
- Select Change route guidance in the destination entry.
- Select Add as waypoint to add the selected destination as a waypoint.
- Select Start guidance to overwrite the current destination.

End route guidance

- Navigate to Navigation, Active route guidance.
- Select End route guidance and confirm or tilt the Multi-Controller to the left.

Switching spoken instructions on or off

- Connect the rider's and passenger's helmets. (▶▶▶ 83)
- Navigation instructions can be read out. For this purpose, Spoken instruction must be switched on.
- Navigate to Navigation, Active route guidance.
- Switch Spoken instruction on or off.

Repeat last spoken instruction

- Navigate to Navigation, Active route guidance.
- Select Current instruction and confirm.

OPERATION

05

IGNITION	92
EMERGENCY-OFF SWITCH (KILL SWITCH)	97
INTELLIGENT EMERGENCY CALL	97
LIGHTING	100
DYNAMIC TRACTION CONTROL (DTC)	103
DYNAMIC SUSPENSION ADJUSTMENT (DSA)	103
RIDING MODE	105
RIDING MODE PRO	108
CRUISE CONTROL	109
RADAR-BASED RIDER ASSISTANCE SYSTEMS	112
DISTANCE CONTROL (ACTIVE CRUISE CONTROL ACC)	114
FRONT COLLISION WARNING (FCW)	118
LANE CHANGE WARNING (SWW)	120
HILL START CONTROL (HSC)	121
ANTI-THEFT ALARM (DWA)	124
TYRE PRESSURE MONITORING (RDC)	127
WINDSCREEN	127
HEATING	128
CENTRAL LOCKING SYSTEM	130
STORAGE COMPARTMENT	132
FRONT AND REAR SEATS	133

92 OPERATION

IGNITION

Radio-operated key

The motorcycle is supplied with one radio-operated key and one spare key. If a key is lost or mislaid, consult the information on the electronic immobiliser (EWS) (▣▣▣ 94).

 The vehicle cannot be started while the radio-operated key is out of range. If the radio-operated key remains out of range the ignition is switched off after about 90 seconds to protect the battery.



Range of the Keyless
Ride radio-operated key

approx. 1 m

After the ignition is switched on (▣▣▣ 93) connection status is indicated by an indicator light in the instrument cluster.



- Indicator light **1** flashes: Locating radio-operated key.
- Indicator light **1** shows: Radio-operated key or spare key not found.
- Indicator light **1** slow-flashes: Radio-operated key not cleared. Move the radio-operated key and switch the ignition on again (▣▣▣ 93).
- Indicator light **1** goes out: Radio-operated key or spare key found and cleared.

Engaging steering lock Requirement

The handlebars are turned towards the left. Radio-operated key is cleared.



- Press and hold down button **1**.
 - » The steering lock engages with an audible click.
 - » Ignition, lights and all function circuits switched off.
- Short-press button **1** to disengage the steering lock.

Switching on ignition Requirement

Radio-operated key is cleared.



- The steering lock can be unlocked once the ignition is switched on.

The steering lock is disengaged:

- Short-press button **1**.
 - » Lights and all function circuits are switched on.
 - » Engine can be started.

Steering lock is engaged:

- Press and hold down button **1**.
 - » The steering lock disengages.
 - » Lights and all function circuits switched on.
 - » Engine can be started.

Switching off ignition Requirement

Radio-operated key is cleared.



- The steering lock can be locked once the ignition is switched off.

To switch off the ignition and engage the steering lock:

- Turn the handlebars all the way to the left.
- Press and hold down button **1**.
 - » Light is switched off.

94 OPERATION

» The steering lock engages.

To switch off the ignition and do not engage the steering lock:

- Short-press button 1.
- » Light is switched off.
- » The steering lock does not engage.

Electronic immobiliser (EWS)

The on-board electronics access the data saved in the ignition key via a ring aerial. The engine control unit will not permit the engine to be started unless the key is identified as "authorised".

 A second ignition key attached to the same ring as the ignition key used to start the engine could "irritate" the electronics, in which case the enabling signal for starting is not issued. The warning with the key symbol appears in the multifunction display. Always keep other vehicle keys separate from the vehicle key used to start the engine.

If you lose a key, you can have it barred by your authorised BMW Motorrad retailer.

If you wish to do this, you will need to bring all other keys for the motorcycle with you. The electrical machine cannot be

started by a barred key, but a key that has been barred can subsequently be reactivated. You can obtain spare keys only through an authorised BMW Motorrad retailer. The keys are part of an integrated security system, so the retailer is under an obligation to check the legitimacy of all applications for replacement/extra keys.

Battery of the radio-operated key is empty or loss of the radio-operated key



- If a key is lost or mislaid, consult the notes on the electronic immobiliser (EWS) ( 94).
- If you happen to lose or mislay the radio-operated key while on a journey, you can start the vehicle with the spare key.
- If the battery of the radio-operated key is empty, the vehicle can be started by

simply inserting the folded radio-operated key into the ring aerial under the seat.

- Remove the rider's seat. (▮▮▮▮ 134)
- Insert the spare key or folded-in radio-operated key with the empty battery **2** into ring aerial **1**.

 The spare key or the closed radio-operated key with the empty battery **must be inserted into** the opening in the ring aerial.



Time during which the engine has to be started. The unlocking procedure has to be repeated if this time is allowed to expire.

30 s

- » Pre-Ride-Check is performed.
- Key has been recognised.
- Engine can be started.
- Install the rider's seat. (▮▮▮▮ 135)
- Start the engine. (▮▮▮▮ 152)

Checking battery voltage of radio-operated key



The battery voltage of the radio-operated key is indicated by the colour of LED **2**.

- Press button **1**.
- » LED shows green: Battery voltage normal
- » LED shows orange: Battery voltage low
- » LED shows red: Battery voltage critical

The battery of the radio-operated key has to be replaced when the LED shows red.

- Replace the battery of the radio-operated key. (▮▮▮▮ 95)

Replacing battery of radio-operated key

If the radio-operated key does not react when you short-press or long-press a button:

- Battery of the radio-operated key is not at full capacity.

96 OPERATION

 Remote key battery weak. Function limited. Change battery.

DANGER

Swallowing a battery

Risk of injury or death

- An ignition key contains a button cell as its battery. Batteries or button cells, if swallowed, can cause serious or fatal injury within two hours, for example resulting from internal burns or caustic action.
 - Keep ignition keys and batteries out of reach of children.
 - If there is any suspicion that a battery or button cell has been swallowed or is inside a part of the body, seek medical assistance immediately.
- Change the battery.



- Press button **1**.
 - » Key bit flips out.
- Push battery cover **2** up.
- Remove battery **3**.
- Dispose of the old battery in accordance with all applicable laws and regulations; do not attempt to dispose of batteries as domestic waste.

ATTENTION

Unsuitable or incorrectly inserted batteries

Component damage

- Use a battery compliant with the manufacturer's specifications.
 - When inserting the battery, always make sure polarity is correct.
- Insert the new battery with the positive terminal up.



For Keyless Ride radio-operated key



Battery type

CR 2032

- Install battery cover **2**.
- » Indicator light in the instrument cluster flashes.
- » The radio-operated key is again ready for use.

EMERGENCY-OFF SWITCH (KILL SWITCH)



- 1** Emergency-off switch (kill switch)



WARNING

Operation of the kill switch while riding

Risk of fall due to rear wheel locking

- Do not operate the kill switch when riding.

The emergency off switch is a kill switch for switching off the engine quickly and easily.



- A** Engine switched off
- B** Normal operating position (run)

INTELLIGENT EMERGENCY CALL

–with intelligent emergency call^{OE}

Emergency call via BMW

Press the SOS button in an emergency only.

The emergency call is not able to be ensured because of technical reasons due to unfavourable conditions, e.g. in areas where there is no mobile phone reception.

During an emergency call, the location of the vehicle, the choice of language and, if applicable, accident-related data are transmitted to BMW (12). Under unfavourable conditions, data transfer can be restricted or delayed. This can

98 OPERATION

lead to delayed processing of the emergency call.

Even if an emergency call using BMW is not possible, the system may make an emergency call to a public emergency call number. This depends on the respective mobile phone network and the national regulations.

Language for emergency call

Each vehicle has a language assigned to it depending on the market for which it is intended. The BMW Call Center answers in this language.

 The language for the emergency call can be changed only by the authorised BMW Motorrad retailer.

The language assigned to the vehicle varies from the selectable language the rider can choose as the display language in the instrument cluster.

Manual emergency call Requirement

An emergency has occurred.
The vehicle is at a standstill.
The ignition is switched on.



- Open cover **1**.
- Short-press SOS button **2**.

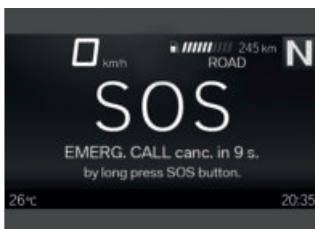

- » The time until transmission of the emergency call is displayed. During that time, it is possible to cancel the emergency call.
- To cancel an emergency call: Press SOS button **2** and hold it down for two seconds or switch the ignition off.
- Operate the emergency-off switch to stop the engine.
- Remove helmet.
- » After expiry of the timer, a voice contact to the BMW Call Center is established.

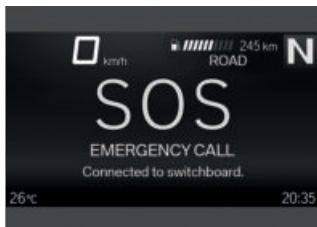

The connection was established.

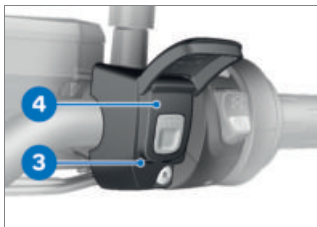

- Provide information to the emergency services using the microphone **3** and speaker **4**.

Automatic emergency call

The intelligent emergency call is active after the ignition is switched on and reacts if a fall or crash occurs.

Emergency call in the event of a light fall

- A minor fall or a crash is detected.
- » An acoustic signal is sounded.

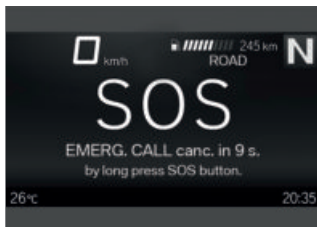

- » The time until transmission of the emergency call is displayed. During that time, it is possible to cancel the emergency call.
- To cancel an emergency call: Press the SOS button and hold it down for two seconds, or switch the ignition off.
- If possible, remove helmet and stop engine.
- » A voice contact connection to the BMW Call Center is established.

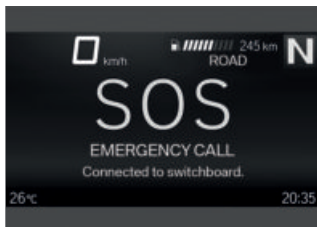

The connection was established.

100 OPERATION

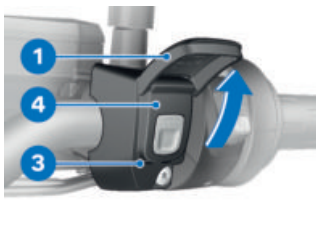

- Open cover **1**.
- Provide information to the emergency services using the microphone **3** and speaker **4**.

Emergency call in the event of a severe fall

- A severe fall or a crash is detected.
 - » The emergency call is placed automatically without delay.

LIGHTING

Low-beam headlight and sidelights

The side lights switch on automatically when the ignition is switched on.

 The side lights place a strain on the battery; leave the ignition switched on for a limited time only.

The low-beam headlight switches on automatically when the engine is started.

In daytime the daytime riding light can be switched on as an alternative to the low-beam headlight.

High-beam headlight and headlight flasher

- Switch on the ignition.
( 93)



- Push switch **1** forward to switch on the high-beam headlight.
- Pull switch **1** back to operate the headlight flasher.

Headlight courtesy delay feature

- Switch off the ignition.
( 93)



- Immediately after switching off the ignition, pull switch **1** back and hold it in that position until the headlight courtesy delay feature comes on.
 - » The vehicle's lights come on for one minute and then switch off automatically.
 - This can be used to light up the path to the house door after the vehicle has been parked, for example.

Parking lights

- Switch off the ignition. (▮▮▮ 93)



- Immediately after switching off the ignition, push button **1** to the left and hold it

in that position until the parking lights come on.

- Switch the ignition on and off again to switch off the parking lights.

Auxiliary headlights

–with additional headlight^{OE}

Requirement

The auxiliary headlights are active only when the low-beam headlight is active.

 The auxiliary headlights are approved as fog lights and can be used only in poor weather conditions. Always comply with the road traffic regulations in force in the country in which the vehicle is used.

- Start the engine. (▮▮▮ 152)
- Navigate to **Settings**, **Vehicle settings**, **Lights** and switch on the **Additional headlight** function.

 shows.

Automatic daytime riding light

 The changeover between daytime riding light and low-beam headlight including front side lights can be effected automatically.

WARNING

The automatic daytime riding light is not a substitute for the rider's personal judgement of the light conditions

Risk of accident

- Switch off the automatic daytime riding light in poor light conditions.
- Navigate to *Settings*, *Vehicle settings*, *Lights* and switch on the *Auto. daytime light* function.
 - » If ambient brightness drops below a certain value, the low-beam headlight is automatically switched on (e.g. in a tunnel). When sufficient ambient brightness is detected, the daytime riding light is switched back on.



shows.

Hazard warning lights

- Switch on the ignition.
( 93)

 The hazard warning flashers place a strain on the battery. Do not use the hazard warning flashers for longer than absolutely necessary.



- Press button **1** to switch on the hazard warning flashers.
 - » Ignition can be switched off.
- Switch the ignition on and press button **1** again to switch off the hazard warning flashers.

Turn indicators

- Switch on the ignition.
( 93)
- Navigate to *Settings*, *Vehicle settings* and select *Lights*.
- Switch *Comfort turn indicator* on or off.



- Push button **1** to the left or right, as appropriate, to switch on the turn indicators.

- » If the comfort turn indicators function is switched on, the turn indicators are cancelled automatically when the speed-dependent distance is covered.
- Alternatively: Press button **1** to cancel the turn indicators.

DYNAMIC TRACTION CONTROL (DTC)

Operating DTC

- Switch on the ignition.
(93)
- Assign the DTC function to the multi-function rocker switch (77).
- Set the desired system status.



When the multi-function rocker switch is pressed for the first time, current system status **1** is displayed.

- Long-press the bottom section of the multi-function rocker switch to switch DTC off.

- » The indicator in the display flashes in sync with the indicator light in the instrument cluster.



flashes yellow.

- Press the top section of the multi-function rocker switch to switch DTC on. Alternatively: Switch ignition off and on again.



goes out, if self-diagnosis has not completed the DTC indicator and warning light starts flashing.

- For more information on Dynamic Traction Control (DTC) see the section entitled "Engineering details" (176).

DYNAMIC SUSPENSION ADJUSTMENT (DSA)

Adjusting suspension damping

—with Dynamic Suspension Adjustment^{OE}



You can adjust the damping characteristic while the motorcycle is on the move.

- Switch on the ignition.
(93)
- Assign the Damping function to the multi-function rocker switch (77).
- Select the appropriate setting.

104 OPERATION



The damping settings **1** can be changed for a different setup, depending on the riding mode.

In ECO, RAIN, ROAD, DYNAMIC and DYNAMIC PRO riding modes, the following settings can be selected:

- Road
- Dynamic

In ENDURO and ENDURO PRO riding modes, the Enduro setting is active.

The damping characteristics of the settings can be adapted in 5 stages, allowing fine-tuning to suit individual preferences.

- To adjust the settings navigate to Settings, Assist, Damping.
- Select the Road, Dynamic or Enduro setting and open the Damping configuration menu.
- Select the -1 or -2 setting to reduce damping.

- Select the +1 or +2 setting to increase damping.

Adjusting ride height

-with Adaptive Ride Height^{OE}

- Switch on the ignition. (▶▶▶ 93)
- Assign the Ride height function to the multi-function rocker switch (▶▶▶ 77).
- Select the appropriate setting.



Ride height can be set to either of two levels **1**.

In ECO, RAIN, ROAD, DYNAMIC and DYNAMIC PRO riding modes, the following settings can be selected:

-Automatic adjustment of ride height



Permanently high ride height

In ENDURO and ENDURO PRO riding modes, the following settings can be selected:



Permanently high ride height



Permanently low ride height

» When the vehicle is brought to a stop the DSA automatically returns to the low ride height, making it easier for the rider to put their feet on the ground.

RIDING MODE

Using riding modes

BMW Motorrad offers you pre-configured modes to suit the various purposes:

Standard

- ECO: Range-optimised riding.
- RAIN: Riding on rain-wet roads.
- ROAD: Riding on dry roads.
- ENDURO: Riding off-road with road tyres.

–with riding modes Pro^{OE}

with riding modes Pro

- DYNAMIC: Dynamic riding on dry roads.
- DYNAMIC PRO: For dynamic riding on dry roadways while taking into account the settings made by the rider.
- ENDURO PRO: For riding off road with off-road tyres with large tread blocks while tak-

ing into account the settings made by the rider.

The optimum interplay of engine characteristic, DTC, ABS and MSR is provided for each of these scenarios.



The default factory setting is ABS deactivated for the rear wheel when the ENDURO PRO riding mode is active.

The chassis and suspension adjustment can also be adjusted in the scenario selected.

For more information on the riding modes, see the section entitled "Engineering details" (▣▶ 185).

Riding-mode preselection

–with riding modes Pro^{OE}

Riding mode preselection is a function for shortlisting the rider's subset of preferred riding modes.

Between two and a maximum of four riding modes can be added to the riding modes preselection shortlist.

Factory setting:

ECO, RAIN, ROAD and ENDURO

106 OPERATION

Preselect a riding mode

—with riding modes Pro^{OE}

- Switch on the ignition.
(▶▶▶ 93)
- Navigate to Settings, Vehicle settings, Riding mode preselection.
- Activate or deactivate riding modes for riding mode preselection.
 - » The activated riding modes are available for subsequent selection.
 - » If fewer than two riding modes are preselected, this message is displayed:
Action not possible.
Min. number reached.
 - » The list of preselected riding modes is retained in memory, even after the ignition is switched off.

Select the riding mode

- Switch on the ignition.
(▶▶▶ 93)
- with riding modes Pro^{OE}
- Preselect a riding mode.
(▶▶▶ 106)◀



- Press button 1.

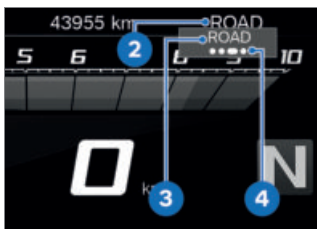

The active riding mode 2 is sent to the back and is displayed in pop-up 3. The guide 4 indicates how many riding modes are available.

**ATTENTION****Activation of the off-road mode (ENDURO and ENDURO PRO) for on-road riding**

Risk of crash due to lack of stability when the vehicle brakes in the control range of ABS or accelerates in that of. DTC

- Activate off-road mode (ENDURO and ENDURO PRO) only for riding off-road.

- Repeatedly press button **1** until the riding mode you want is displayed.

–with riding modes Pro^{OE}



The default setting is ABS deactivated for the rear wheel when the ENDURO PRO riding mode is active.<

–with riding modes Pro^{OE}



The intervention of riding dynamics control systems can be restricted, depending on which riding mode is selected and how the selected mode is configured.

Possible restrictions are indicated by a pop-up message, for example **Warning! ABS setting..**

The ABS indicator light flashes irregularly.

See the section entitled "Engineering details" for more information on riding dynamics control systems such as ABS.<

- » The availability of the riding modes depends on the custom configuration of the riding modes preselection function.
- » With the motorcycle at a standstill, the selected riding mode is activated after approximately two seconds.
- » The following conditions must be satisfied for activation of a new riding mode while riding:
 - Throttle grip is in idle position.
 - Brake is not applied.
 - Adaptive cruise control is not active.
 - » The selected riding mode is retained with the engine-characteristic, DTC, ABS and MSR adaptation settings even after the ignition has been switched off.

108 OPERATION

RIDING MODE PRO

–with riding modes Pro^{OE}

Adjustment option

The Pro riding modes can be set up to suit individual rider needs and preferences.

Selecting Pro riding mode

- Switch on the ignition.
(▮▮▮ 93)
- Navigate to Settings, Vehicle settings, Riding mode preselection.
- Select ENDURO PRO riding mode or DYNAMIC PRO riding mode.
- Call up Configuration.

Setting up Enduro Pro

–with riding modes Pro^{OE}

- Select Pro riding mode.
(▮▮▮ 108)

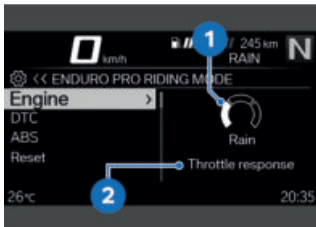

The Engine system has been selected. The current setting is displayed as a diagram **1** with explanatory texts relating to the system **2**.

- Select system and confirm.

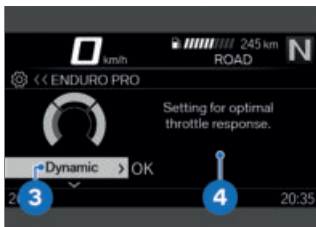

You can browse through the available settings **3** and the corresponding explanations **4**.

- Set up the system.
» The Engine, DTC and ABS systems can be set up in the same way.

Setting up Dynamic Pro

- Select Pro riding mode.
(▮▮▮ 108)
- Set up the systems in the same way as with ENDURO PRO riding mode.

Resetting riding mode settings

- Select Pro riding mode.
(▮▮▮ 108)
- Select Reset and confirm.
» The following factory settings apply for ENDURO PRO RIDING MODE:
 - ENGINE: Road
 - DTC: Enduro Pro
 - ABS: Enduro Pro

- » The following factory settings apply for DYNAMIC PRO RIDING MODE:
- ENGINE: Dynamic
 - DTC: Road
 - ABS: Dynamic

CRUISE CONTROL

Display when adjusting settings (Speed Limit Info not active)



Symbol **1** for cruise control is displayed in the Pure Ride view and in the top status line.

Display when adjusting settings (Speed Limit Info active)



Symbol **1** for cruise control is displayed in the Pure Ride view and in the top status line.

Switching on cruise control Requirement

ECO, RAIN, ROAD, DYNAMIC or DYNAMIC PRO riding mode is selected.

 In ENDURO and ENDURO PRO riding modes, cruise control is not available.



- Slide switch **2** to the right.
- » Button **1** is operational.

110 OPERATION

Setting road speed



- Short-push button **1** forward.

 Adjustment range for cruise control (gear-dependent)

30...210 km/h

 is displayed.

- » The motorcycle maintains your current cruising speed and the setting is saved.

Accelerating



- Short-push button **1** forward.
 - » Speed is increased by approx. 1 km/h each time you push the button.

- Push button **1** forward and hold it in this position.
 - » Speed is increased in steps of 10 km/h.
 - » The current speed is maintained and saved if button **1** is not pushed again.

Decelerating

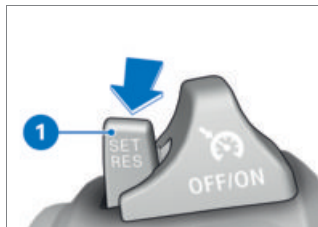



- Short-push button **1** back.
 - » Speed is reduced by approx. 1 km/h each time you push the button.
- Push button **1** back and hold it in this position.
 - » Speed is reduced in steps of 10 km/h.
 - » The current speed is maintained and saved if button **1** is not pushed again.

Deactivating cruise control

- Brake or turn the throttle grip (close the throttle by turning the grip back past the idle position) to deactivate cruise control.

 Cruise control is deactivated if the clutch is pulled for longer than 1.5 seconds.

 For safety reasons, cruise control is automatically deactivated whenever ABS or DTC intervention occurs. If DTC is deactivated by the rider, cruise control is deactivated as well.

 is greyed.

Automatic deactivation

Adaptive cruise control is deactivated automatically in the following situations:

- When engine speed drops below the minimum threshold (to prevent stalling).
- After several seconds when the vehicle is ridden at maximum engine speed.
- During ABS or DTC interventions.
- If a system fault occurs.

If adaptive cruise control experiences automatic deactivation, a message to this effect is displayed.

Resuming former cruising speed

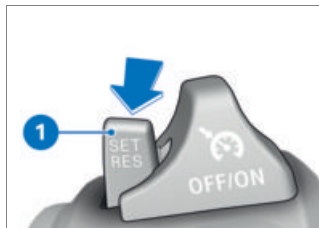

- Short-push button **1** back to return to the speed saved beforehand.

 Opening the throttle does not deactivate cruise control. If you release the twistgrip the motorcycle will decelerate only to the cruising speed saved in memory, even though you might have intended slowing to a lower speed.

 Indicator light for cruise control shows.

Switching off cruise control

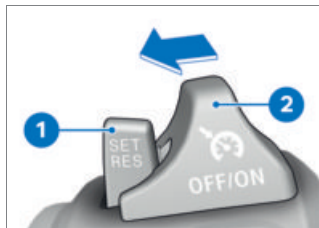

- Slide switch **2** to the left.

112 OPERATION

» The system is deactivated.



disappears.

» Button 1 is disabled.

Configure the character of cruise control

–with Riding Assistant^{OE}

- Switch on the ignition.
(93)
- Navigate to Settings, Assist and select Cruise control.
- Select ACC characteristics.
- Select the desired setting.
» The following settings for acceleration and deceleration are possible:
 - Comfortable: Balanced acceleration and deceleration of the vehicle.
 - Dynamic: More sharply pronounced acceleration and deceleration of the vehicle for a more dynamic style of riding.

RADAR-BASED RIDER ASSISTANCE SYSTEMS

–with Riding Assistant^{OE}

Safety information

Distance control (ACC), Front Collision Warning (FCW) and lane change warning (SWW) are radar-based rider assistance systems. Functional restrictions and the limits of the systems must be taken into consideration.



WARNING

Rider is not relieved of responsibility to ride safely

Risk of accident due to misjudgement by the systems

- The rider assistance systems are not safety systems. The responsibility for correctly gauging visibility conditions and the traffic situation and intervening accordingly resides with you.



WARNING

Radar cannot detect all objects and traffic situations

Risk of accident

- Radar-based rider assistance systems detect only moving vehicles. This means that for example pedestrians, animals and stationary vehicles are not detected. Cyclists cannot be reliably detected.

- Object detection can be restricted, for example on twisting or hilly roads and when you ride offset from the vehicle ahead in your lane or if you weave from side to side in the lane.
- The front radar (ACC, FCW) does not react to oncoming vehicles and there is a time lag in detection of a vehicle cutting into your lane ahead of you.
- For system-rated reasons, on account of these restrictions, a late warning and sharp application of the brakes can occur or the brakes might not be applied or a warning issued.
- Keep the traffic conditions under observation at all times and intervene actively whenever the situation requires.

**WARNING****Radar is not functional in certain situations**

Risk of accident due to non-application of the brakes or non-issue of a warning

- The front and rear radar systems require a clear view for object detection to work well. Object detection is restricted in heavy rain, fog or snow and also if the radar sensors are dirty or obstructed.
- Object detection can be disrupted by environmental influences such as strong reflections and electromagnetic disturbances.
- If the vehicle is involved in an accident or experiences an impact with an object or is dropped, the installed positions of the radar sensors have to be checked.
- Keep the traffic conditions under observation at all times and intervene actively whenever the situation requires.



ATTENTION

Radar might incorrectly detect certain objects and traffic situations

Risk of accident

- Radar-based rider assistance systems might respond without justification in reaction to certain objects and complex traffic situations. For example a narrowed traffic lane (roadworks) or objects in the air (e.g. a bouncing ball or a plastic bag) can lead to a warning being issued or the brakes being applied by ACC or FCW.
- Keep the traffic conditions under observation at all times and intervene actively whenever the situation requires.



WARNING

ACC cannot compensate for excessive speed differences

Risk of accident

- ACC cannot perform emergency braking. Retardation and the rate at which retardation increases are limited.
- High speed differences, for example when you come up fast behind a truck or when another vehicle cuts into your lane ahead of you, cannot be compensated for by the system.
- When the adjustment range of ACC is exceeded, object detection might be delayed on account of the high speed. Consequently, increased rider caution is required in these circumstances.
- Keep the traffic conditions under observation at all times and intervene actively whenever the situation requires.

DISTANCE CONTROL (ACTIVE CRUISE CONTROL ACC)

—with Riding Assistant^{OE}

Safety information

Also follow the safety instructions for radar-based rider assistance systems

( 112).

**WARNING****ACC can lose sight of an object detected beforehand**

Risk of accident

- When ACC incorrectly deselects a detected object, the motorcycle accelerates back up to the road speed set beforehand. This can be the case in bends, for example.
- Keep the traffic conditions under observation at all times and intervene actively whenever the situation requires.

**WARNING****ACC cannot slow the vehicle sufficiently when the vehicle corners at high speed**

Risk of accident

- The cornering regulator reduces road speed when distance control is active and the bank angle is excessive. If a vehicle is detected ahead, retardation of the vehicle is built up more slowly while the motorcycle is banked.
- Ride at a correspondingly lower speed.



When riding in other countries, always comply with the country-specific regulations on the operation of radar sensors. If the radar sensor does not have the licence required by a particular country's laws, the radar sensor has to be disconnected. It is best to consult an authorised BMW Motorrad retailer.

Toggle between cruise control and ACC

- Switch on the ignition. (▣▣▣▶ 93)
- Configure the character of cruise control. (▣▣▣▶ 112)

**WARNING****Reduced assistance after changeover to cruise control**

Risk of accident

- By contrast with ACC, cruise control does not react to traffic ahead. Instead, it matches the vehicle's road speed to the setting selected by the rider.
- Keep the traffic conditions under observation at all times and intervene actively whenever the situation requires.

116 OPERATION

- Navigate to Settings, Assist, select Cruise control.
- Activate or deactivate ACC.
- **Alternatively:** Assign the ACC function to the multi-function rocker switch (▮▮▮▮ 77).

ACC is inactive:

- Short-press the bottom section of the multi-function rocker switch to view the current status.
 - Short-press the bottom section of the multi-function rocker switch again to activate ACC.
- » This toggles between cruise control and ACC.

ACC is active:

- Long-press the top section of the multi-function rocker switch to view the current status.
 - Long-press the top section of the multi-function rocker switch again to deactivate ACC.
- » This toggles between ACC and cruise control.
- Bear in mind the information on automatic deactivation (▮▮▮▮ 111).
 - For more information on distance control with Active Cruise Control (ACC) see the

section entitled "Engineering details" (▮▮▮▮ 180).

Operating ACC Requirement

ACC is activated.

 ACC is not available in ENDURO and ENDURO Pro riding modes.

- Switch on cruise control. (▮▮▮▮ 109)

 is greyed.

- Set the road speed. (▮▮▮▮ 110)

 At speeds above its adjustment range 30...160 km/h, the system regulates to the maximum speed of 160 km/h.

- Short-press the multi-function rocker switch.



The currently set approach distance **1** is displayed.

Status indicators showing in the instrument cluster

When ACC is in operation, the following symbols can appear in the instrument cluster:

Indicator lights

» No object detected:



shows green.

» Object detected:



shows green.

» Rider overrides by twisting the throttle grip to open the throttle:



shows green.

Warning lights

» ACC switched off for system-related reason, or system-related deactivation is imminent:



is displayed in red.

» A hazardous situation has been detected and cannot be averted.



flashes red.

If a warning light shows in the instrument cluster:

- Intervene actively to avert potential danger.

Setting approach distance

- Assign the ACC function to the multi-function rocker switch (▶▶ 77).
- Short-press the multi-function rocker switch.



The currently set approach distance **1** is displayed.

WARNING

Selected approach distance is too short for the riding situation

Risk of accident

- Adapt your approach distance to suit traffic and weather conditions.
- Comply with the safety distance required by law.

- Select the appropriate setting.

118 OPERATION

» The following settings are available:



Short approach distance



Medium approach distance



Long approach distance

» When the ACC detects a vehicle travelling in front, a depiction of a car appears in the symbol shown here to alert the rider.

» The approach-distance setting is retained in memory, even after the ignition is switched off.

FRONT COLLISION WARNING (FCW)

–with Riding Assistant^{OE}

Safety information

Also follow the safety instructions for radar-based rider assistance systems (➔ 112).



WARNING

FCW can lose sight of an object detected beforehand

Risk of accident

- If FCW loses sight of an object detected beforehand a warning might not be issued or its application of the brakes might be cancelled. This can be the case in bends, for example.
- Keep the traffic conditions under observation at all times and intervene actively whenever the situation requires.



WARNING

FCW cannot slow the vehicle sufficiently when the vehicle corners at high speed

Risk of accident

- At an excessively steep bank angle FCW warns with a weaker alert and builds up braking assistance more slowly and to a lower maximum value.
- Ride at a correspondingly lower speed.

Behaviour of front collision warning

 FCW is available only in the ECO, RAIN, ROAD and DYNAMIC riding modes.

See the "Engineering details" section for more information on FCW (►► 182).

Warning lights

If FCW has detected a critical riding situation, the following symbols can appear in the instrument cluster:

Advance warning

» Warning pulse is activated:



lights up red.

» Warning pulse is deactivated:



flashes red.

Acute warning

» Brake assistance is activated:



flashes red.

» Brake assistance is deactivated:



flashes full-screen red.

If a warning light shows in the instrument cluster:

- Intervene actively to avert potential danger.

Setting timing for issue of warning

- Navigate to Settings, Assist, select Front-collision warning.
- Select Warning.

The following points in time can be selected:

- Early
- Medium
- Late

Setting warning pulse

- Navigate to Settings, Assist, select Front-collision warning.
- Select Warning pulse.

» The following settings are available:

- Activated: In addition to issue of the advance warning, an attention-enhancing braking pulse is triggered.
- Deactivated: Only the advance warning is issued.

Setting brake assistance

 Brake assistance is designed to help defuse critical situations and bridge the rider's reaction time. Manual intervention by the rider is necessary nonetheless.

120 OPERATION

- Navigate to Settings, Assist, select Front-collision warning.
- Select Braking assistance.
 - » The following settings are available:
 - Activated: In addition to issue of the acute warning, a braking manoeuvre is initiated to assist the rider.
 - Deactivated: Only the acute warning is issued.

Deactivating anti-theft alarm system (FCW)

- Navigate to Settings, Assist, select Front-collision warning.
- Navigate to Warning and select Off to deactivate.

 Haptic interventions of the function can be activated or deactivated individually in the Front-collision warning menu, without the function in its entirety having to be deactivated.

 FCW is deactivated manually in the menu or by selection of the Pro or ENDURO riding modes.

» FCW is deactivated:

 is displayed.

- See the "Engineering details" section for more information on FCW (➡ 182).

LANE CHANGE WARNING (SWW)

–with Riding Assistant^{OE}

Behaviour of lane change warning

Also follow the safety instructions for radar-based rider assistance systems (➡ 112).

If lane change warning is active and a critical riding situation for a lane change is encountered, the warnings behave as follows:



Notification

–Warning triangle 1 lights up until the critical riding situation has passed.

Acute warning

–If actuation of the turn indicators on the side corresponding to the lit-up warning triangle indicates an imminent lane change, warning triangle **1** flashes because a safe lane change is not possible.

 If the **Urgent only** setting is selected, only the acute warning with a flashing warning triangle is issued.

For more information on lane change warning see the "Engineering details" section (▮▮▮ 183).

The brightness of the warning triangle depends on ambient brightness or, as applicable, on the brightness of the instrument cluster (▮▮▮ 82).

Setting lane change warning

- Navigate to **Settings, Assist**, select **LCW**.

 In the factory setting, lane change warning is active by default. A change to the setting is retained in memory after the ignition is switched off.

» The following settings are available:

- Off**: SWW is deactivated, neither notifications nor acute warnings are issued.
- On**: SWW is active, both notifications and acute warnings are issued.
- Urgent only**: SWW is active, only acute warnings are issued.

HILL START CONTROL (HSC)

Display

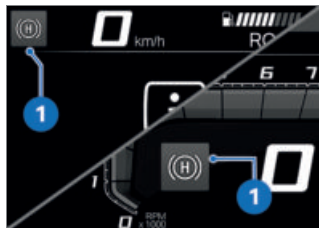

Symbol **1** is displayed in the Pure Ride view or in the top status line.

Switch Hill Start Control on or off

- Switch on the ignition. (▮▮▮ 93)
- Navigate to **Settings, Vehicle settings**.
- Switch Hill Start Control on or off.

122 OPERATION

Operating Hill Start Control Requirement

Vehicle stationary and upright, engine running.

ATTENTION

Non-availability of Hill Start Control

Risk of accident

- Apply the brakes manually to hold the vehicle.

 Hill Start Control is purely a comfort system that facilitates hill starts and consequently, is not to be confused with a parking brake.

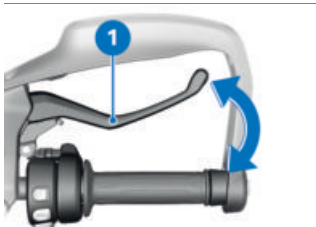

- Apply firm pressure to handbrake lever **1** or to the footbrake lever and then quickly release the lever.

 shows green.

- » Hill Start Control is activated.
- To switch off Hill Start Control, operate handbrake

lever **1** or the footbrake lever again.

 disappears.

- Alternatively, ride off in 1st or 2nd gear.

 In order for the motorcycle to pull away from rest with Hill Start Control, the throttle grip has to be turned to open the throttle for pullaway.

 disappears as soon as the brake is fully released.

- » Hill Start Control is deactivated.
- See the "Engineering details" section for more information on Hill Start Control ( 193).

Operating Hill Start Control Pro

—with riding modes Pro^{OE}

Requirement

Vehicle stationary and upright, engine running.

ATTENTION

Non-availability of Hill Start Control

Risk of accident

- Apply the brakes manually to hold the vehicle.

 Hill Start Control Pro is purely a comfort system that facilitates hill starts and consequently, is not to be confused with a parking brake.

 Hill Start Control Pro should not be used on gradients steeper than 40 %.

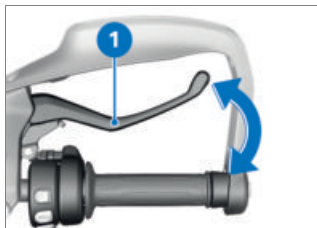

- Apply firm pressure to handbrake lever **1** or to the footbrake lever and then quickly release the lever.
- Alternatively, apply the brake for about one second beyond the vehicle reaching a standstill on an incline of at least 3 %.

 shows green.

- » Hill Start Control Pro is activated.
- To switch off Hill Start Control Pro, operate handbrake lever **1** or the footbrake lever again.

 If Hill Start Control Pro has been deactivated by means of the handbrake lever, automatic Hill Start Control is deactivated for the next 4 m.

 disappears.

- Alternatively, ride off in 1st or 2nd gear.

 In order for the motorcycle to pull away from rest with Hill Start Control Pro, the throttle grip has to be turned to open the throttle for pullaway.

 disappears as soon as the brake is fully released.

- » Hill Start Control Pro is deactivated.
- See the "Engineering details" section for more information on Hill Start Control Pro (➡ 193).

Adjust Hill Start Control Pro –with riding modes Pro^{OE}

- Switch on the ignition. (➡ 93)
- Navigate to **Settings**, **Vehicle settings**.
- Select **HSC Pro**.
- To switch off Hill Start Control Pro, select **Off**.
- » Hill Start Control Pro is deactivated.

124 OPERATION

- To switch on manual Hill Start Control Pro, select **Manual**.
 - » Hill Start Control Pro can be activated by forcefully operating the handbrake or foot-brake lever.
- To switch on automatic Hill Start Control Pro, select **Auto**.
 - » Hill Start Control Pro can be activated by forcefully operating the handbrake or foot-brake lever.
 - » If the brake is actuated for approximately one second after the vehicle has come to a standstill and the motor-cycle is on a gradient of at least 3 %, Hill Start Control Pro is automatically activated.
 - » The selected setting remains stored even after the ignition is switched off.

ANTI-THEFT ALARM (DWA)

—with anti-theft alarm (DWA)^{OE}

Activation

- Switch on the ignition.
(▶▶▶ 93)
 - Customise the anti-theft alarm settings. (▶▶▶ 126)
 - Switch off the ignition.
(▶▶▶ 93)
 - » If the anti-theft alarm system (DWA) is activated, the alarm system is armed automatically when you switch the ignition off.
- » Activation takes approximately 30 seconds to complete.
 - » Turn indicators flash twice.
 - » Confirmation tone sounds twice (if programmed).
 - » Anti-theft alarm (DWA) is active.
- Switch off the ignition.
(▶▶▶ 93)
 - Press button **1** on the radio-operated key twice.
 - » Activation takes approximately 30 seconds to complete.
 - » Turn indicators flash twice.
 - » Confirmation tone sounds twice (if programmed).
 - » Anti-theft alarm is active.



- To deactivate the tilt sensor (for example if you are about to transport the motorcycle on a train and the swaying movement of the moving train could trip the alarm), press button **1** on the radio-oper-

ated key again during the activation phase.

- » Turn indicators flash three times.
- » Confirmation tone sounds three times (if programmed).
- » Tilt sensor is deactivated.

Alarm signal

A DWA alarm can be triggered by:

- Tilt sensor
- Switch-on attempt with an unauthorised vehicle key.
- Disconnection of the DWA anti-theft alarm from the vehicle's battery (DWA internal battery in the anti-theft alarm provides power - acoustic alarm only, the turn indicators do not flash)

All functions are sustained even if the internal battery of the DWA anti-theft alarm system is flat; the only difference is that an alarm cannot be triggered if the system is disconnected from the vehicle's battery.

An alarm lasts for approximately 29 seconds. While an alarm is in progress an alarm tone sounds and the turn indicators flash. The type of acoustic alarm tone can be set by an authorised BMW Motorrad retailer.



You can cancel an alarm at any time by pressing button **1** on the radio-operated key; this does not deactivate the DWA.

If an alarm was triggered while the motorcycle was unattended, the rider is notified accordingly by an alarm tone sounding once when the ignition is switched on. The DWA LED then indicates the reason for the alarm for one minute.

Light signals issued by the indicator light:

- Flashes 1x: Tilt sensor 1
- Flashes 2x: Tilt sensor 2
- Flashes 3x: Ignition switched on with unauthorised key
- Flashes 4x: Disconnection of the DWA anti-theft alarm from the motorcycle's battery
- Flashes 5x: Tilt sensor 3

126 OPERATION

Deactivation

- Kill switch in operating position (run).
- Switch on the ignition.
(▶▶▶ 93)



- Press button **1** on the radio-operated key once.

i If the alarm function is deactivated by the radio-operated key and the ignition is not subsequently switched on, the alarm function is automatically reactivated after approx. 30 seconds if Arm automatically is switched on.

- » Turn indicators flash once.
- » Confirmation tone sounds once (if programmed).
- » DWA is switched off.

Customise the anti-theft alarm settings

- Switch on the ignition.
(▶▶▶ 93)
- Navigate to Settings, Vehicle settings, Alarm system.

» The following settings are available:

- Adapting Warning signal
 - Switch Tilt sensor on or off
 - Switch Arming tone on or off
 - Switch Arm automatically on or off
- » Possibilities for adjustment
(▶▶▶ 126)

Possibilities for adjustment

Warning signal: Set the rising and falling or intermittent alarm tone.

Tilt sensor: Activate tilt sensor to monitor the inclination of the vehicle. The anti-theft alarm is tripped if any attempt is made to steal a wheel or lift the vehicle for towing, for example.

i When the vehicle is going to be transported, deactivate the tilt sensor to prevent the anti-theft alarm (DWA) from being triggered.

Arming tone: In addition to turn indicators flashing, alarm tone sounds as confirmation of activation/deactivation of the DWA.

Arm automatically: Automatic activation of the alarm

function after the ignition is switched off.

TYRE PRESSURE MONITORING (RDC)

Switch the target-pressure warning on or off

- The system can be set to issue a target-pressure warning if tyre pressure drops to the defined minimum.
- Navigate to *Settings*, *Vehicle settings*, *RDC*.
- Switch *Target pressure warn.* on or off.

WINDSCREEN

Adjusting windscreen



WARNING

Adjusting the windscreen while riding

Risk of falling

- Do not attempt to adjust the windscreen unless the motorcycle is at a standstill.

- Pull lever **2** down to raise windscreen **1**.
- Push lever **2** up to lower windscreen **1**.

Electrically adjusting windscreen

–with windscreen, electrically adjustable^{OE}

- Switch on the ignition. (▣▣▣ 93)
- » As you ride off, the windscreen automatically moves to its last position before the ignition was switched off.
- Assign the *Windscreen* function to the multi-function rocker switch (▣▣▣ 77).
- Select the appropriate setting.

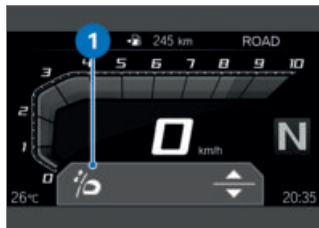

Windscreen adjustment **1** takes place directly when the multi-function rocker switch is pressed for the first time.

- Switch off the ignition. (▣▣▣ 93)

128 OPERATION

» The windscreen automatically moves to the bottom end position.

If the windscreen encounters resistance before it reaches its end position, the anti-trap mechanism goes active. The windscreen stops and the mechanism raises it slightly. After a few seconds the windscreen once again attempts to move to the bottom end position.

- Make sure that nothing obstructs the windscreen's freedom of movement.
- » Windscreen does not react when the multi-function rocker switch is pressed.
- Consult a specialist workshop, preferably an authorised BMW Motorrad retailer.

There is no guarantee that the anti-trap system will function correctly if a windscreen that does not have BMW Motorrad approval is installed.

- Under these circumstances: Before switching off the ignition, make sure that nothing obstructs the windscreen's freedom of movement.

HEATING

Operating heated handlebar grips

 The heating in the heated handlebar grips can be activated only when the engine is running.

 The increase in power consumption caused by having the heated handlebar grips switched on can drain the battery if you are riding at low engine speeds. If the charge level is low, the heated handlebar grips are switched off to ensure the battery's starting capability.

- Start the engine. (▮▮▮ 152)
- Assign the Grip heating function to the multi-function rocker switch (▮▮▮ 77).
- Select the appropriate setting.



The handlebar grips have three-stage heating **1**.

Operate the heating

—with seat heating^{OE}

 The heating in the heated handlebar grips and the seat heating can be activated only when the engine is running.

- Start the engine. (▶▶▶ 152)
- Assign the Heating function to the multi-function rocker switch (▶▶▶ 77).
- Press the top section of the multi-function rocker switch to adjust the grip heating setting.
- Press the bottom section of the multi-function rocker switch to adjust the seat heating setting.



The handlebar grips **1** and the rider's seat **2** each have three-stage heating. High heating power is for heating quickly: it is advisable to switch back to a lower heating power soon.

Operating passenger-seat heating

—with seat heating^{OE}

—with two-up riding package^{OE}

- Start the engine. (▶▶▶ 152)

 Seat heating can be activated only when the engine is running.



- Set switch **1** to the desired heating stage.

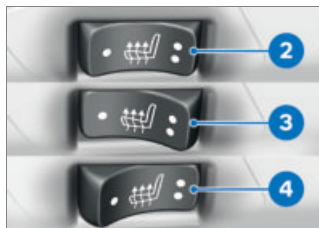

The rear seat has two-stage heating. Stage two is for heating the seat quickly: it is advisable to switch back to stage one as soon as the seat is warm.

—**2** Switch centred: Heating off.

130 OPERATION

- 3 Switch pressed at one dot: low heating power.
- 4 Switch pressed at two dots: high heating power.



Selected heating stage **1** and seat-heating symbol **2** are displayed.

CENTRAL LOCKING SYSTEM

Locking

-with central locking system^{OE}



- Switch off the ignition.
(→ 93)
- Press button **1**.
-with case^{OA}
» The cases are locked.<
- with topcase^{OA}
» The topcase is locked.<

Unlocking

-with central locking system^{OE}

 The central locking unlocks automatically when you switch on the ignition.



- Press button **1**.
-with case^{OA}
» The cases are unlocked.<
- with topcase^{OA}
» The topcase is unlocked.<
- » Once a lock has been locked manually it subsequently has to be unlocked manually as well.

Automatic locking

-with central locking system^{OE}
-with case^{OA}
or
-with central locking system^{OE}
-with topcase^{OA}

- Navigate to **Settings**,
Vehicle settings.
- **Activate the Lock when ignition off function.**

» Cases and topcase are automatically locked after the ignition has been switched off.

Emergency unlocking

–with central locking system^{OE}
–with case^{OA}

or

–with central locking system^{OE}
–with topcase^{OA}

Requirement

If the central locking system refuses to unlock or if cases and topcase have been locked and removed, you can open the cases and topcase manually. The procedure is as follows:

–with central locking system^{OE}
–with case^{OA}



- Turn the key to the **RELEASE** position in the case lock.
 - Turn the key in the case lock to position **1** and remove the key from the lock.
- » Case is unlocked.<

–with central locking system^{OE}
–with topcase^{OA}

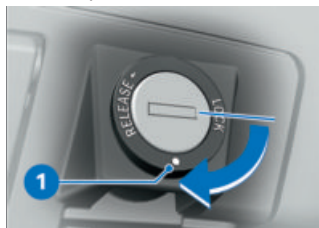

- Turn the key to the **RELEASE** position in the topcase lock.
- Turn the key in the topcase lock to position **1** and remove the key from the lock.



- Fully open locking flap **1**.
- » Topcase is unlocked.<

132 OPERATION

STORAGE COMPARTMENT

Opening and closing storage compartment

ATTENTION

High temperatures in the storage compartments, particularly in summer

Damage to objects stowed away, particularly electronic devices, such as mobile phones

- In summer, do not place heat-sensitive items in the storage compartment.
- Ask the manufacturer about possible usage restrictions and comply with the information provided.

ATTENTION

Vibrations when vehicle is moving

Damage to mobile phones carried on the vehicle

- Make sure that the mobile phone carried on the vehicle is suitable for use on the motorcycle. Ask the manufacturer about related usage restrictions and comply with the information provided.



- To open, press slide **2** and flip storage compartment flap **1** open.
- To close, press storage compartment flap **1** closed.

 The storage compartment cannot be locked. Access to the storage compartment can be prevented by turning the handlebars to full lock and engaging the steering lock.

Dimensions

The storage compartment is suitable for smartphones up to max. 162 mm x 78 mm x 8.8 mm in size.

For further information about the USB charging socket in the storage compartment see the section entitled "Accessories" (▮▮▮ 237).

FRONT AND REAR SEATS

Removing passenger seat

- Make sure the ground is level and firm and place the motorcycle on its stand.



- Turn vehicle key **1** clockwise and hold it in this position.
- Slightly raise passenger seat **2** at the rear and release the vehicle key.

—with seat heating^{OE}

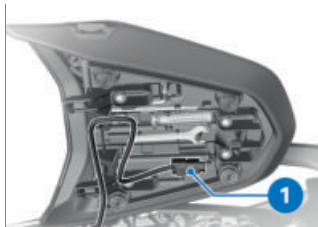

- Disconnect plug connection **1** of the seat heating.◁
- Place the passenger seat, upholstered side down, on a clean, dry surface.

Installing passenger seat

—with seat heating^{OE}

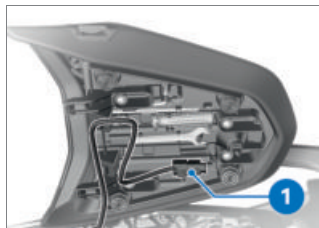

- Connect plug connection **1** of the seat heating.◁



- Position passenger seat **1** in the rear frame at the front and press down on the seat at the rear.

» The passenger seat engages with an audible click.

Adjusting passenger seat

—with two-up riding package^{OE}

134 OPERATION



- Slightly lift passenger seat **1**.

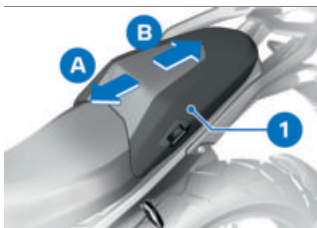

- Slide passenger seat **1** in direction **A** or **B**.



- Press passenger seat **1** down.
» The passenger seat engages with an audible click.

Removing rider's seat

- Remove the rear seat.
(▶▶▶ 133)

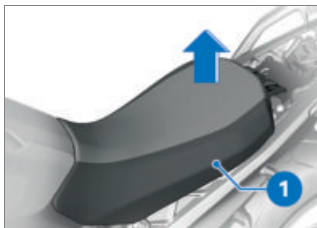

- Lift the rear of the rider's seat.

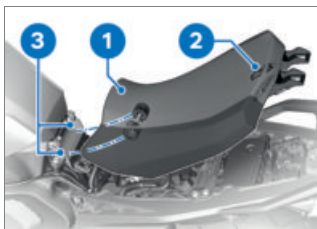

- Remove rider's seat **1** from mount **3**.
—with seat heating^{OE}
- Disconnect plug connection **2** of the seat heating.◁
- Place the rider's seat, upholstered side down, on a clean, dry surface.

Installing rider's seat

–with seat heating^{OE}

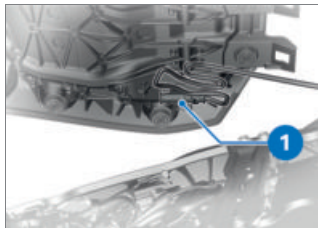

- Connect plug connection **1** of the seat heating.◁



- Engage the rider's seat in mounts **2** on left and right and lower it on to the motorcycle.
- Applying pressure to the rear of the seat, push the front seat slightly forward and then press the seat firmly down.
- Install the passenger seat.
(▶▶▶ 133)

ADJUSTMENT

06

MIRRORS	138
HEADLIGHT	139
CLUTCH	140
GEARSHIFT LEVER	140
BRAKES	141
FOOTRESTS	142
HANDLEBARS	143
SPRING PRELOAD	144

138 ADJUSTMENT

MIRRORS

Adjusting mirrors



- Turn the mirror to the correct position.

Adjusting mirror arm

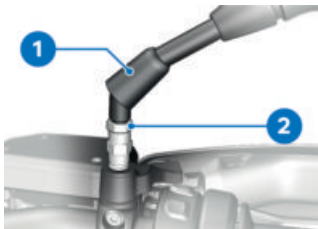

- Push protective cap **1** up to expose lock nut **2** on the mirror arm.
- Slacken lock nut with left-hand thread **2**.
- Turn the mirror arm to the appropriate position.
- Tighten lock nut **2** to the specified tightening torque, while holding the mirror arm to ensure that it does not move out of position.

 Mirror (lock nut) to adapter

M10 x 1.25

22 Nm (Left-hand thread)

- Push protective cap **1** over the threaded fastener.

—with Riding Assistant^{OE}

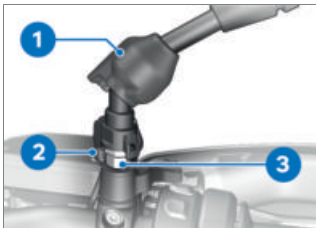

- Push protective cap **1** over the threaded fastener of the mirror arm up to expose the threaded fastener.
- Unclip plug connection **2** at the mirror base.
- Slacken lock nut with left-hand thread **3**.
- Turn the mirror arm to the appropriate position.
- Tighten lock nut **3** to the specified tightening torque, while holding the mirror arm to ensure that it does not move out of position.

 Mirror (bottom lock nut) to adapter

M10 x 1.5



Mirror (bottom lock nut)
to adapter

22 Nm

- Clip in plug connection **2** at the mirror base.
- Push protective cap **1** over the threaded fastener. ◀

HEADLIGHT

Headlight beam throw and spring preload

Headlight beam throw is generally kept constant when spring preload is adjusted to suit load.

Spring preload adjustment might not suffice only if the motorcycle is very heavily loaded. Under these circumstances, headlight beam throw has to be adjusted to suit the weight carried by the motorcycle.



If there are doubts about the correct headlight beam throw, have the setting checked by a specialist workshop, preferably an authorised BMW Motorrad retailer.

Adjusting headlight beam throw

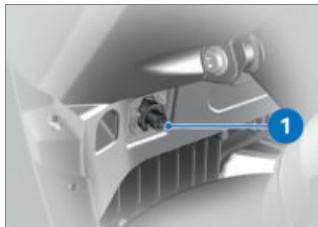

If, for a high load, the adjustment of the spring pre-load is no longer sufficient not to dazzle oncoming traffic:

- Switch on the ignition. (▮▮▮ 93)
- Start the engine. (▮▮▮ 152)
- Adjust headlight beam throw by turning adjusting screw **1** with the tool from the on-board toolkit.

When the motorcycle is again ridden with a lower load:

- Return the headlight to its basic setting.

140 ADJUSTMENT

CLUTCH

Adjusting clutch lever



WARNING

Adjusting the clutch lever while riding

Risk of accident

- Adjust the clutch lever only when the motorcycle is at a standstill.

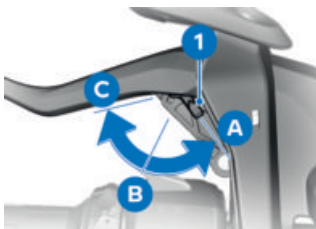

- Push adjustment lever **1** to the desired position.

 The adjustment lever is easier to move when the clutch lever is pushed slightly forward.

» Adjustment options:

- Position A: Narrowest span between handlebar grip and clutch lever
- Position B: Medium span between handlebar grip and clutch lever

–Position C: Widest span between handlebar grip and clutch lever

- Check the and protector. (143)

GEARSHIFT LEVER

Adjusting gearshift lever peg



ATTENTION

Unintentional operation of the gearshift lever

Damage to the gearbox

- Check that the gearshift lever is in the correct position.
- Make sure that the gearshift lever is under no load except when gearshifting is in progress.

–with enduro package Pro^{OE}

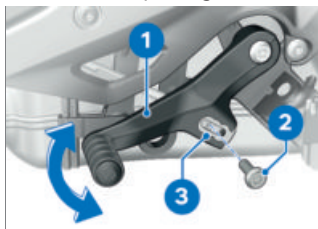

- Slacken screw **2**.
- Push gearshift lever **1** to the desired position.
- Insert screw **2** in one of the three countersinks **3**.

- Tighten screw **2**.

 Screw to gearshift lever and gearshift lever adjuster

M6 x 20

8 Nm 

–with Option 719 Billet Pack Shadow^{OE}



- Slacken screw **2**.
- Push gearshift lever **1** to the desired position.
- Insert screw **2** in one of the two countersinks **3**.
- Tighten screw **2**.

 Screw to gearshift lever and gearshift lever adjuster

M6 x 20

8 Nm 

BRAKES

Adjusting handbrake lever

 **WARNING**

Adjusting the handbrake lever while riding

Risk of accident

- Do not attempt to adjust the handbrake lever unless the motorcycle is at a standstill.

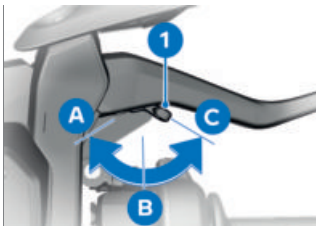

- Push adjustment lever **1** to the desired position.

 The adjustment lever is easier to move when the handbrake lever is pushed forward.

» Adjustment options:

- Position A: Narrowest span between handlebar grip and handbrake lever
- Position B: Medium span between handlebar grip and handbrake lever

142 ADJUSTMENT

–Position C: Widest span between handlebar grip and handbrake lever

- Check the and protector. (▮▮▮▮▶ 143)

Adjust the footbrake lever peg

–with Option 719 Billet Pack Shadow^{OE}

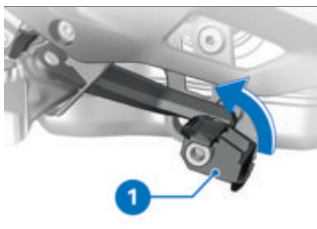

- Foot clearance and height relative to peg 1 can be adjusted by turning the peg 90°.
- Pull peg 1 out and turn it to the desired position.◁

–with enduro package Pro^{OE}

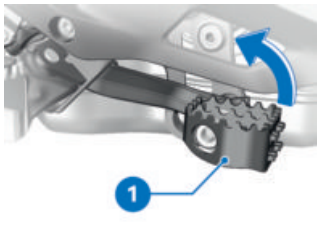

- Foot clearance and height relative to peg 1 can be adjusted by turning the peg 90°.

- Pull peg 1 out and turn it to the desired position.◁

FOOTRESTS

–with enduro package Pro^{OE}
or
–with sport suspension^{OE}

Adjusting footrests

- The footrest is adjusted on the right and left in the same way.
- The position of the footrest must be set identically on the right and on the left.

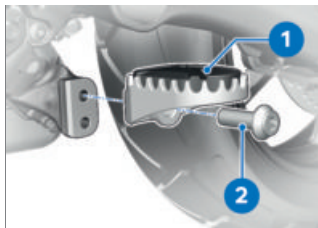

- Remove screw 2.
- Remove rider footrest 1.

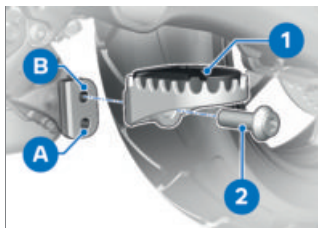

- Install rider footrest **1** in desired position **A** or **B** and tighten screw **2**.

 Rider footrest to footrest joint

M10 x 30

56 Nm

- After adjusting the footrests, adjust the brake lever and gearshift lever pegs to suit, if necessary.
- Adjust the gearshift lever peg. (▣▣▣▶ 140)
- Adjust the footbrake lever peg. (▣▣▣▶ 142)

HANDLEBARS

Adjustable handlebars

Have the handlebars adjusted by a specialist workshop, preferably an authorised BMW Motorrad retailer.

 When adjusting the handlebars, make sure that the mirrors do not come into contact with the windscreen. If necessary, adjust the mirror arm accordingly.

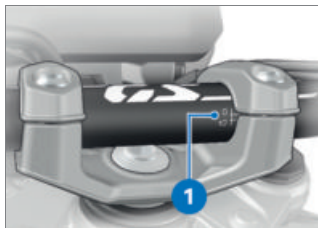

The tilt of the handlebars is adjustable within the range indicated by mark **1**.

 Additional components are needed for replacing the handlebars. Have the handlebars replaced by a specialist workshop, preferably an authorised BMW Motorrad retailer.

Checking hand protector

If the hand protector is twisted out of position, a lack of clearance between hand protector and handlebar lever can lead to continuous actuation of the handlebar lever. Clutch or brake malfunctions are possible.

144 ADJUSTMENT

- Check the position of the hand protector and check that the handlebar lever has sufficient clearance, particularly after the following events:
 - Change of ergonomics settings
 - Accident or fall
 - Inappropriate transport
 - Loosened threaded fasteners



- Check the clearance between hand protector **1** and handlebar lever **2** on left and right. If the handlebar lever contacts the hand protector or if the handlebar lever cannot be moved forward easily from its idle position:
 - Have the hand protector positioned correctly by a specialist workshop, preferably an authorised BMW Motorrad retailer.



Turn indicators are not horizontally at right angles to the motorcycle's longitudinal axis:

- Have the hand protector positioned correctly by a specialist workshop, preferably an authorised BMW Motorrad retailer.

 The turn indicators are integrated into the hand protectors. If a hand protector is twisted out of position, the turn indicator might not be correctly aligned so as to be compliant with the road traffic regulations.

SPRING PRELOAD

–without Dynamic Suspension Adjustment^{OE}

Adjustment

It is essential to set spring preload of the rear suspension to suit the load carried by the motorcycle. Increase spring preload when the vehicle is heavily loaded and reduce spring

preload accordingly when the vehicle is lightly loaded.

Adjusting spring preload for rear wheel



WARNING

Adjusting spring preload while riding.

Risk of accident

- Do not attempt to adjust spring preload unless the motorcycle is at a standstill.
- Make sure the ground is level and firm and place the motorcycle on its stand.

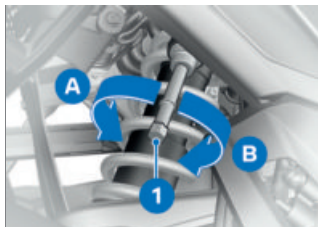

- To increase spring preload, use the tool from the on-board toolkit to turn hexagon **1** clockwise in direction **B**.
- To reduce spring preload, use the tool from the on-board toolkit to turn hexagon **1** counter-clockwise in direction **A**.



Basic setting of spring preload, rear

Turn the hexagon head counter-clockwise as far as it will go (with full load of fuel, with rider weighing approx. 85 kg)

Turn the hexagon head as far as it will go counter-clockwise, then back it off 14 turns clockwise (One-up with luggage approx. 105 kg)

Turn the hexagon head as far as it will go counter-clockwise, then back it off 30 turns clockwise (Two-up with luggage approx. 165 kg)

- If the load differs from the base settings, increase spring preload two full turns for every 10 kg of extra weight.

RIDING

07

SAFETY INFORMATION	148
REGULAR CHECK	151
STARTING	152
RUNNING IN	155
OFF-ROAD USE	156
SHIFTING GEAR	157
BRAKES	158
PARKING YOUR MOTORCYCLE	160
LIFT ASSISTANCE	161
REFUELLING	163
SECURING MOTORCYCLE FOR TRANSPORTATION	166

SAFETY INFORMATION

Rider's equipment

Do not ride without the correct clothing! Always wear

- Helmet
- Suit
- Gloves
- Boots

This applies even to short journeys, and to every season of the year. Your authorised BMW Motorrad retailer will be happy to advise you on the correct clothing for every purpose.

WARNING

Loose textiles, items of luggage or straps snagged by open rotating parts of the vehicle (wheels, drive shaft)

Risk of accident

- Make sure that loosely worn or carried textiles cannot be snagged by openly rotating parts of the vehicle.
- Keep all items of luggage and straps well clear of openly rotating parts of the vehicle.

Load

WARNING

Handling adversely affected by overloading and imbalanced loads

Risk of falling

- Do not exceed the permissible gross weight and be sure to comply with the instructions on loading.

WARNING

Handling adversely affected by overloading and imbalanced loads

Risk of falling

- Do not exceed the permissible gross weight and be sure to comply with the instructions on loading.



–without Dynamic Suspension Adjustment^{OE}

- Adjust the setting of the spring preload to the total weight.◀

–with case^{OA}

- Ensure that the case volumes on the left and right are equal.
- Make sure that the weight is uniformly distributed between right and left.

- Pack heavy items at the bottom and toward the inboard side.
 - Note the maximum permissible payload and maximum permissible speed, see also the section entitled "Accessories" (►► 243).◁
- with topcase^{OA}
- Note the maximum permissible payload and maximum permissible speed, see also the section entitled "Accessories" (►► 248).◁
- with tank bag^{OA}
- Note the maximum permissible payload and maximum speed for riding with the tank bag.

	Payload of tank rucksack
	max 5 kg
	Maximum speed for riding with a loaded tank bag
	max 180 km/h◁

Speed

If you ride at high speed, always bear in mind that various boundary conditions can adversely affect the handling of your motorcycle. They include:

- Setup of the suspension
- Imbalanced load
- Loose clothing
- Insufficient tyre pressure
- Poor tyre tread

Maximum speed with knobbly tyres or winter tyres



DANGER

Maximum speed of the motorcycle is higher than the permissible maximum rated speed of the tyres

Risk of accident due to tyre damage at high speed

- Comply with the tyre-specific speed restrictions.

Always bear the maximum permissible speed of the tyres in mind when riding a motorcycle fitted with knobbly tyres or winter tyres.

Affix a label stating the maximum permissible speed to the instrument panel in the rider's field of vision.

Risk of poisoning

Exhaust fumes contain carbon monoxide, which is colourless and odourless but highly toxic.

WARNING

Exhaust gases adversely affecting health

Risk of asphyxiation

- Do not inhale exhaust fumes.
- Do not run the engine in an enclosed space.

WARNING

Inhalation of harmful vapours

Health hazard

- Do not inhale vapours from operating fluids and plastics.
- Use the vehicle only outdoors.

Risk of burning

CAUTION

Engine and exhaust system become very hot when the vehicle is in use

Risk of burn injury

- When you park the vehicle make sure that no-one and no objects can come into contact with the hot engine and exhaust system.

WARNING

Opening radiator cap

Risk of burning

- Do not open the radiator cap when the system is hot.
- Check and, if necessary, top up the coolant in the expansion tank only.

Catalytic converter

If misfiring causes unburned fuel to enter the catalytic converter, there is a danger of overheating and damage.

The following guidelines must be observed:

- Do not run the fuel tank dry.
- Do not attempt to start or run the engine with a spark-plug cap disconnected.
- Stop the engine immediately if it misfires.
- Use only unleaded fuel.
- Comply with all specified maintenance intervals.

ATTENTION

Unburned fuel in catalytic converter

Damage to catalytic converter

- Note the points listed for protection of the catalytic converter.

Risk of overheating



ATTENTION

Engine running for prolonged period with vehicle at standstill

Overheating due to insufficient cooling; in extreme cases vehicle fire

- Do not allow the engine to idle unnecessarily.
- Ride away immediately after starting the engine.

Tampering



ATTENTION

Tampering with the motorcycle (e.g. engine management ECU, throttle valves, clutch)

Damage to the affected parts, failure of safety-relevant functions, voiding of warranty

- Do not tamper with the vehicle in any way that could result in tuned performance.

REGULAR CHECK

Comply with checklist

At regular intervals, use the checklist below to check your motorcycle.

Always before riding off

- Check operation of the brake system (➡ 204).
- Check operation of the lights and signalling equipment.
- Check operation of the clutch (➡ 209).
- Check the tyre tread depth (➡ 211).
- Check the tyre pressures (➡ 210).
- Check security of cases and luggage.

Every 3rd refuelling stop

- Check the engine oil level (➡ 202).
- Check the brake pad thickness, front brakes (➡ 205).
- Check the brake pad thickness, rear brakes (➡ 206).
- Check the brake-fluid level, front brakes (➡ 207).
- Check the brake-fluid level, rear brakes (➡ 208).
- Check the coolant level (➡ 209).

152 RIDING

STARTING

Starting engine

- Switch on the ignition. (▣▣▣ 93)
 - » Pre-Ride-Check is performed. (▣▣▣ 152)
 - » ABS self-diagnosis is performed. (▣▣▣ 153)
 - » DTC self-diagnosis is performed. (▣▣▣ 154)
- Select neutral or, if a gear is engaged, pull the clutch lever.

 You cannot start the motorcycle with the side stand extended and a gear engaged. The engine will switch itself off if you start it with the gearbox in neutral and then engage a gear before retracting the side stand.

- Cold starts and low temperatures: Pull the clutch lever.
 - » Low temperatures can impact on the starting response. Repeated, brief application of load on the battery causes battery temperature to rise, so more battery power is available for starting the engine.



- Press starter button **1** and hold it down until the engine fires.
 - » If the engine refuses to start, consult the troubleshooting chart in the section entitled "Technical data" (▣▣▣ 262)
- Recharge the battery before you try again to start the engine, or use jump leads and a donor battery to start:
- Recharge the battery connected to the vehicle. (▣▣▣ 226)
 - Jump-start. (▣▣▣ 223)

 The start attempt is automatically interrupted if battery voltage is too low.

Pre-Ride-Check

The instrument cluster runs a test of the instruments and the indicator and warning lights when the ignition is switched on. This test is known as the Pre-Ride-Check. The test is aborted if you start the engine before it completes.

Phase 1

All indicator and warning lights are switched on.

After a longer vehicle standstill period, an animation is displayed when the system starts up.

Phase 2

The 'General' warning light changes from red to yellow.

Phase 3

All the indicator and warning lights switched on in the initial phase are switched off in reverse sequence.

The malfunction indicator lamp (MIL) does not go out until 15 seconds have elapsed.

If one of the indicator and warning lights did not switch on:

- Have the fault rectified as quickly as possible by a specialist workshop, preferably an authorised BMW Motorrad retailer.

–with riding modes Pro^{OE}



The intervention of riding dynamics control systems can be restricted, depending on which riding mode is selected and how the selected mode is configured.

Possible restrictions are indic-

ated by a pop-up message, for example Warning! ABS setting..

The ABS indicator light flashes irregularly.

See the section entitled "Engineering details" for more information on riding dynamics control systems such as ABS.<

ABS self-diagnosis

BMW Motorrad Integral ABS Pro performs self-diagnosis to ensure its operability. Self-diagnosis starts automatically when you switch on the ignition.

Phase 1

- » Test of the diagnosis-compatible system components with the vehicle at a standstill.



flashes.

Phase 2

- » Test of the wheel-speed sensors as the vehicle pulls away from rest.



flashes.

ABS self-diagnosis completed

- » The ABS indicator and warning light goes out.



ABS self-diagnosis not completed

The ABS function is not available, because self-diagnosis did not complete. (The motorcycle has to reach a defined minimum speed with the engine running for the wheel sensors to be checked: min 5 km/h)

If an indicator showing an ABS fault is displayed after ABS self-diagnosis completes:

- You can continue to ride. Bear in mind that neither the ABS function nor the integral braking function is available.
- Have the fault rectified as quickly as possible by a specialist workshop, preferably an authorised BMW Motorrad retailer.

DTC self-diagnosis

BMW Motorrad DTC performs self-diagnosis to ensure its operability. Self-diagnosis is performed automatically when you switch on the ignition.

Phase 1

» Test of the diagnosis-compatible system components with the vehicle at a standstill.



slow-flashes.

Phase 2

» Pullaway test of the diagnosis-compatible system components.



slow-flashes.

DTC self-diagnosis completed

» The DTC symbol no longer shows.

- Check all the indicator lights.



DTC self-diagnosis not completed

The DTC function is not available, because self-diagnosis did not complete. (The motorcycle has to reach a defined minimum speed with the engine running for the wheel sensors to be checked: min 5 km/h)

If an indicator showing an DTC fault is displayed after DTC self-diagnosis completes:

- You can continue to ride. Bear in mind that the DTC function is not available at all, or the functionality might be subject to certain restrictions.
- Have the fault rectified as quickly as possible by a specialist workshop, preferably an

authorised BMW Motorrad retailer.

RUNNING IN

Engine

- Until the first running-in check, vary the throttle opening and engine-speed range frequently; avoid riding at constant engine rpm for prolonged periods.
- Try to do most of your riding during this initial period on twisting, fairly hilly roads.
- Comply with the running-in speeds.



Running-in speeds

<5000 min⁻¹ (Odometer reading 0...1000 km)

No full load (Odometer reading 0...1000 km)

- Note the mileage after which the running-in check should be carried out.



Mileage until the running-in check

500...1200 km

Brake pads

New brake pads have to be run in before they can achieve their optimum friction levels. You can compensate for this initial reduction in braking efficiency by exerting greater pressure on the levers.



WARNING

New brake pads

Longer stopping distance, risk of accident

- Apply the brakes in good time.

Tyres

New tyres have a smooth surface. This must be roughened by riding in a restrained manner at various heel angles until the tyres are run in. This running in procedure is essential if the tyres are to achieve maximum grip.



WARNING

New tyres losing grip on wet roads and at extreme bank angles

Risk of accident

- Ride carefully and avoid extremely sharp inclines.

OFF-ROAD USE

For off-roading Tyre pressure

WARNING

Lower tyre pressure for off-roading in operation on smooth roads

Risk of accident due to impaired driving characteristics.

- Always check that the tyre pressures are correct.

Brakes

WARNING

Driving on unpaved or dirt roads

Delayed braking efficiency due to soiled brake disks and brake pads.

- Brake early until the brakes are clean.

ATTENTION

Riding on unsurfaced or dirty roads

Increased brake pad wear

- Check the thickness of the brake pads more frequently and replace the brake pads in good time.

Wheel rims

ATTENTION

Off-roading more severe than riding on unsurfaced tracks

Damage to standard cast-aluminium rims

- For severe off-roading, use the cross-spoked wheels or enduro forged wheels available as optional extras.

BMW Motorrad recommends checking the rims for damage after off-roading.

—with off-road tyres^{OE}

Spray guard

ATTENTION

Severe off-roading and lengthy rides on unsurfaced tracks

Damage to the spray guard

- For severe off-roading with cleated tyres, remove the spray guard from the rear wheel.

Remove the spray guard (🔧 217).

Install the spray guard (🔧 220).

Air filter element



ATTENTION

Dirty air filter element

Engine damage

- If you ride in dusty terrain check the air filter element for clogging at shorter intervals; clean or replace as necessary.

Operation in very dusty conditions (desert, steppes, or the like) necessitates the use of air filter elements specially designed for conditions of this nature.

SHIFTING GEAR

–with shift assistant Pro^{OE}

Gear Shift Assistant Pro



- Select the gears in the usual way by using the foot-operated gearshift lever.
- » The shift assistant assists upshifts and downshifts without

the rider having to pull the clutch or close the throttle.

–This is not an automatic-shift system.

–The rider is the most important part of the system and decides when to shift gears.

–The sensor **1** on the gearshift shaft registers the gearshift request and triggers shift assistance.

» When you are riding at constant speed or in overrun in a low gear with the engine revving high, shifting gear without disengaging the clutch can cause a severe reaction to the load change. BMW Motorrad recommends disengaging the clutch for shifts in these circumstances.

» Shift assistance is not available in the following situations:

–With clutch lever pulled.

–Gearshift lever is not in its initial position

- Once the gearshift has completed, the gearshift lever has to be fully released before another gearshift with the Pro can take place.

- For more information on Gear Shift Assistant Pro see the section headed "Engineering details" (192).

BRAKES

How can stopping distance be minimised?

Each time the brakes are applied, a load distribution shift takes place with the load shifting forward from the rear to the front wheel. The sharper the motorcycle decelerates, the more load is shifted to the front wheel. The higher the wheel load, the more braking force can be transmitted without the wheel locking. To optimise stopping distance, apply the front brakes rapidly and keep on increasing the force you apply to the brake lever. This makes the best possible use of the dynamic increase in load at the front wheel. Remember to pull the clutch at the same time. In the "emergency braking situations" that are trained so frequently, braking force is applied as rapidly as possible and with the rider's full force applied to the brake levers; under these circumstances the dynamic shift in load distribution cannot keep pace with the increase in deceleration and the tyres cannot transmit the full braking force to the surface of the road.

BMW Motorrad Integral ABS Pro prevents the front wheel from locking up.

Emergency braking

If you brake sharply from a speed in excess of >50 km/h, the brake light flashes rapidly as a warning for road users behind you.

If you brake until your speed is less than <15 km/h, the hazard warning lights start to flash as well. The hazard warning lights switch off automatically as soon as you start to accelerate and vehicle speed reaches 20 km/h.

Descending mountain passes



WARNING

Braking mostly with the rear brake on mountain descents

Brake fade, destruction of the brakes due to overheating

- Use both front and rear brakes, and make use of the engine's braking effect as well.

Wet and dirty brakes



WARNING

Wetness and dirt result in diminished braking efficiency

Risk of accident

- Apply the brakes lightly while riding to remove wetness and dirt, or dismount and clean the brakes.
- Think ahead and brake in good time until full braking efficiency is restored.

Wetness and dirt on the brake discs and the brake pads diminish braking efficiency.

Delayed braking action or poor braking efficiency must be reckoned with in the following situations:

- Riding in the rain or through puddles of water.
- After the vehicle has been washed.
- Riding on salted or gritted roads.
- After work has been carried on the brakes, due to traces of oil or grease.
- Riding on dirt-covered surfaces or off-road.

ABS Pro

Physical limits applicable to motorcycling



WARNING

Braking when cornering

Risk of crash despite ABS Pro

- Invariably, it remains the rider's responsibility to adapt riding style to riding conditions.
- Do not take risks that would negate the additional safety offered by this system.

ABS Pro and the assisting function of the Dynamic Brake Control are available in all riding modes except Enduro PRO.

Possibility of a fall not precluded

Although ABS Pro and Dynamic Brake Control provide the rider with valuable assistance and constitute a huge advance in safety for braking with the motorcycle banked for cornering, they cannot under any circumstances be considered as re-defining the physical limits that apply to motorcycling. It is still possible for these limits to be overshoot due to misjudgement or rider error. In extreme cases this can result in a crash.

160 RIDING

Use on public roads

ABS Pro and Dynamic Brake Control help make the motorcycle even safer for riding on public roads. When the brakes are applied because of an unforeseen hazard when the motorcycle is banked for cornering, within the physical limits that apply to motorcycling the ABS Pro system prevents the wheels from locking and skidding away. In emergency braking, Dynamic Brake Control increases the braking effect and intervenes if the throttle grip is accidentally turned during braking.

 ABS Pro was not developed to enhance individual braking performance with the motorcycle banked into corners.

PARKING YOUR MOTORCYCLE

Side stand

- Switch off the ignition.
( 93)



ATTENTION

Poor ground underneath the stand

Risk of damage to parts if vehicle topples

- Always check that the ground under the stand is level and firm.



ATTENTION

Additional weight placing strain on the side stand

Risk of damage to parts if vehicle topples

- Do not sit or lean on the vehicle while it is propped on the side stand.

- Extend the side stand and prop the motorcycle on the stand.
- Turn the handlebars all the way to the left.
- On a gradient, the motorcycle should always face uphill; select 1st gear.

Centre stand

—with centre stand^{OE}

- Switch off the ignition.
( 93)

**ATTENTION****Poor ground underneath the stand**

Risk of damage to parts if vehicle topples

- Always check that the ground under the stand is level and firm.

**ATTENTION****Centre stand retracts due to severe movements**

Risk of damage to parts if vehicle topples

- Do not lean or sit on the vehicle with the centre stand extended.
- On a gradient, always park the motorcycle facing uphill; select 1st gear.

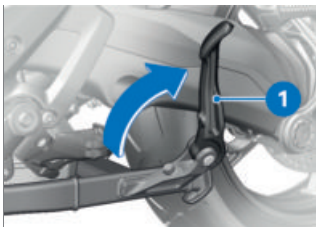

- Flip peg on centre stand **1** open.
- Press your foot down on peg **1** of the centre stand and

lift the motorcycle on to the stand.

- with Adaptive Ride Height^{OE}
- Lift assistance helps you to lift the motorcycle on to its centre stand (➡ 161).◁

**WARNING****Centre stand contacts ground if not fully retracted**

Risk of accident

- Before riding off, fully retract the centre stand.
- Before riding off, fully retract the peg.
- After removing the motorcycle from the stand, first retract the centre stand, then flip the peg of the centre stand **1** closed.

LIFT ASSISTANCE

–with Adaptive Ride Height^{OE}

How the lift assistance function works

The lift assistance function makes it easier to lift the vehicle on to its centre stand. By automatically extending the suspension it gives the rider a better mechanical advantage for lifting the vehicle on to the centre stand. Less effort is

162 RIDING

needed to lift the motorcycle on to the stand.

 A sensor detects extension of the centre stand as a request to prepare for lifting the vehicle on to its stand and readies the suspension accordingly.

Operating lift assistance

 Repeated actuation of the lift assistance function can drain the battery. Actuation of the lift assistance function can be repeated only a certain number of times. Further attempts require the ignition to be switched off and then on again.

- Switch on the ignition.
( 93)

ATTENTION

Poor ground underneath the stand

Risk of damage to parts if vehicle topples

- Always check that the ground under the stand is level and firm.

ATTENTION

Centre stand retracts due to severe movements

Risk of damage to parts if vehicle topples

- Do not lean or sit on the vehicle with the centre stand extended.

- On a gradient, always park the motorcycle facing uphill; select 1st gear.

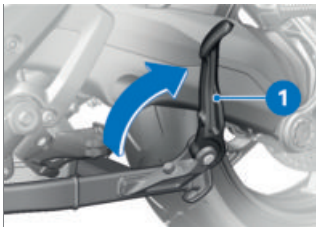

- Flip peg on centre stand **1** open.
- Press your foot down on peg **1** of the centre stand and lift the motorcycle on to the stand.
 - » The suspension automatically adjusts to the maximum height.
 - » When the motorcycle is on the stand the suspension automatically adjusts to the lowest height to increase stability.

**WARNING****Centre stand contacts ground if not fully retracted**

Risk of accident

- Before riding off, fully retract the centre stand.
 - Before riding off, fully retract the peg.
- After removing the motor-cycle from the stand, first retract the centre stand, then flip the peg of the centre stand **1** closed.
- » When you ride off the suspension returns automatically to the ride height selected beforehand.

REFUELLING**Fuel grade****Requirement**

For optimum fuel consumption, fuel should be sulphur-free or as low-sulphur as possible.

**ATTENTION****Engine operation with leaded fuel**

Damage to catalytic converter

- Do not attempt to run the vehicle on leaded fuel or fuel with metallic additives (e.g. manganese or iron).

- Observe the maximum ethanol content of the fuel.



Fuel additives clean the fuel injection system and the combustion zone. It is advisable to use fuel additives when the engine is operated with low-grade fuel or if the vehicle is to be out of use for a lengthy period of time. More information is available from your authorised BMW Motorrad retailer.



Recommended fuel grade



Premium unleaded (max 15 % ethanol, E10/E15)



95 ROZ/RON
90 AKI



Alternative fuel grade



Normal unleaded (power- and consumption-related restrictions.) (max 15 % ethanol, E10/E15)



91 ROZ/RON
87 AKI

- » Look for these symbols on the fuel filler cap and on the fuel pump:



E10

» After refuelling with fuels of poor-quality, sporadic knocking noises may be perceptible.

Refuelling

Requirement

The steering lock is disengaged.



WARNING

Fuel is highly flammable

Risk of fire and explosion

- Do not smoke. Never bring a naked flame near the fuel tank.



WARNING

Escape of fuel due to heat-induced expansion if fuel tank is overfilled

Risk of falling

- Do not overfill the fuel tank.



ATTENTION

Wetting of plastic surfaces by fuel

Damage to the surfaces (surfaces become unsightly or dull)

- Clean plastic surfaces immediately after contact with fuel.

–without centre stand^{OE}

- Make sure the ground is level and firm and place the motorcycle on its side stand.◁

–with centre stand^{OE}

- Make sure the ground is level and firm and place the motorcycle on its centre stand.◁

- Switch off the ignition.

(→ 93)



The fuel filler cap can be opened within the defined waiting time after the ignition has been switched off, without the radio-operated key being within range.



Waiting time for opening the fuel filler cap

2 min

- » There are **two variant ways** of opening the fuel filler cap:
- Within the waiting time.

–After the waiting time has expired.

Variant 1

Requirement

Within the waiting time

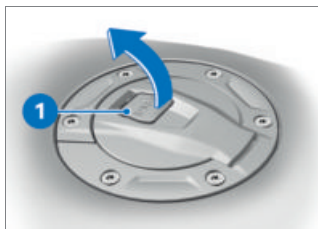

- Slowly pull tab **1** on the fuel filler cap up.
- » Fuel filler cap unlocks.
- Fully open the fuel filler cap.

Variant 2

Requirement

After the waiting time has expired

- Bring the radio-operated key into range.
- Slowly pull tab **1** up.
- » The indicator light for the radio-operated key flashes while the search for the radio-operated key is in progress.
- Slowly pull tab **1** on the fuel filler cap up again.
- » Fuel filler cap unlocks.
- Fully open the fuel filler cap.



- Refuel with fuel of the grade stated above; do not fill the tank past the bottom edge of the filler neck.

 When refuelling after running on reserve, make sure that you top up the tank to a level above reserve, so that the new level is detected and the fuel reserve indicator light is switched off.

 The "usable fuel capacity" specified in the technical data is the quantity that the fuel tank could hold if refilled after it had been run dry and the engine had cut out due to a lack of fuel.



Usable fuel capacity

approx. 19 l



Reserve fuel

approx. 4 l

166 RIDING

- Press down firmly on the filler cap of the fuel tank.
 - » The fuel filler cap engages with an audible click.
 - » The fuel filler cap locks automatically when the waiting time expires.
 - » The engaged fuel filler cap locks immediately when you secure the steering lock or switch on the ignition.

Opening fuel filler cap emergency release

Fuel filler cap cannot be opened.

- Have the fault rectified as quickly as possible by a specialist workshop, preferably an authorised BMW Motorrad retailer.

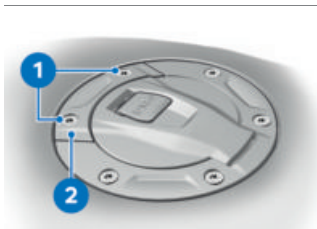

- Remove screws **1**.
- Remove emergency release **2**.
 - » Fuel filler cap unlocks.
- Fully open the fuel filler cap.
- Refuel. (►►► 164)
- Close the fuel filler cap emergency release. (►►► 166)

Closing fuel filler cap emergency release Requirement

Fuel filler cap is in closed position.

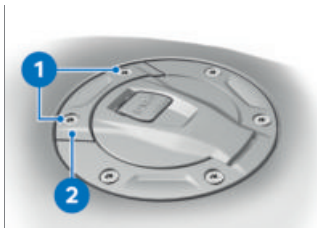

- Hold emergency release **2** in position.
- Install screws **1**.

SECURING MOTORCYCLE FOR TRANSPORTATION



ATTENTION

Incorrect lashing

Component damage

- Never lash anything to add-on parts such as the engine protection bars, for example.
- Secure tensioning belts only to the components described as suitable for this purpose.
- Make sure that all components that might come into contact with straps used to secure the motorcycle are ad-

equately protected against scratching. Use adhesive tape or soft cloths, for example, for this purpose.



ATTENTION

Vehicle topples to side when being lifted on to stand

Risk of damage to parts if vehicle topples

- Secure the vehicle to prevent it toppling, preferably with the assistance of a second person.
- Push the motorcycle on to the transportation flat and hold it in position: do not place it on the side stand or centre stand.
- Have a helper hold the motorcycle to make sure that it cannot topple.



ATTENTION

Trapping of components

Component damage

- Do not trap components such as brake lines or cable legs.
- Pass the straps on left and right through the fork bridge and strap the motorcycle down.



- At the rear, secure the straps to the holders for the passenger footrests on both sides and tighten the straps.

168 RIDING

- Tension all the straps uniformly to hold the vehicle securely.

ENGINEERING DETAILS

08

GENERAL NOTES	172
ANTILOCK BRAKE SYSTEM (ABS)	172
DYNAMIC TRACTION CONTROL (DTC)	176
DYNAMIC ENGINE BRAKE CONTROL (MSR)	178
BATTERY GUARD	178
SHUTDOWN CONCEPT	179
DISTANCE CONTROL (ACTIVE CRUISE CONTROL ACC)	180
FRONT COLLISION WARNING (FCW)	182
LANE CHANGE WARNING (SWW)	183
DYNAMIC SUSPENSION ADJUSTMENT (DSA)	184
RIDING MODE	185
DYNAMIC BRAKE CONTROL	190
TYRE PRESSURE CONTROL (RDC)	190
GEAR SHIFT ASSISTANT	192
HILL START CONTROL (HSC)	193
SHIFTCAM	195
CORNERING HEADLIGHT	195

172 ENGINEERING DETAILS

GENERAL NOTES

To find out more about engineering, go to bmw-motorrad.com/technik.

ANTILOCK BRAKE SYSTEM (ABS)

Fully integral brakes

Your motorcycle has fully integral brakes. With this system, when either brake lever (hand-brake or footbrake lever) is actuated both the front and the rear brakes are applied.

The BMW Motorrad fully integral ABS adapts brake force distribution between front and rear brakes to suit the load on the motorcycle whenever braking requires ABS intervention. Brake force distribution is dependent on riding mode and can be set up to suit the rider.



ATTENTION

Attempted burn-out despite Integral braking function

Damage to rear brake and clutch

- Do not burn out tyres.

How does ABS work?

The amount of braking force that can be transferred to the road depends on factors that include the coefficient of friction of the road surface. Loose stones, ice and snow or a wet road all have much lower coefficients of friction than a clean and dry asphalt surface. The lower the coefficient of friction, the longer the stopping distance.

If the rider increases braking pressure to the extent that braking force exceeds the maximum transferable limit, the wheels start to lock and the motorcycle loses its directional stability; a fall is imminent. Before this situation can occur, ABS intervenes and adapts braking pressure to the maximum transferable braking force. The wheels continue to turn and the driving stability is retained irrespective of the road condition.



The default factory setting is ABS deactivated for the rear wheel when the ENDURO PRO riding mode is active.

What are the effects of surface irregularities?

Humps and surface irregularities can cause the wheels to lose contact temporarily with the road surface; if this happens the braking force that can be transmitted to the road can drop to zero. If the brakes are applied under these circumstances the ABS has to reduce braking force to ensure that directional stability is maintained when the wheels regain contact with the road surface. At this instant the BMW Motorrad Integral ABS Pro must assume an extremely low coefficient of friction (gravel, ice, snow), so that the wheels will continue to rotate under all imaginable circumstances, because this is the precondition for ensuring directional stability. As soon as it registers the actual circumstances, the system reacts instantly and adjusts braking force accordingly to achieve optimum braking.

What feedback does the rider receive from the BMW Motorrad Integral ABS Pro?

If the ABS system has to reduce braking force on account of the circumstances described above, vibration is perceptible through the handbrake lever. When the handbrake lever is pulled, brake pressure is also built up at the rear wheel by the integral function. If the brake pedal is depressed after the handbrake lever is pulled, the brake pressure built up beforehand is perceptible as counter-pressure sooner than in the case when the brake pedal is depressed either before or at the same time as the brake lever is pulled.

Rear wheel lift

Under very severe and sudden deceleration, however, under certain circumstances it is possible that the BMW Motorrad Integral ABS Pro will be unable to prevent the rear wheel from lifting clear of the ground. If this happens the outcome can be a highside situation in which the motorcycle can flip over.



WARNING

Rear wheel lift due to severe braking

Risk of falling

- When you brake sharply, bear in mind that ABS control cannot always be relied on to prevent the rear wheel from lifting clear of the ground.

What is the design baseline for BMW Motorrad Integral ABS Pro?

Within the limits imposed by physics, BMW Motorrad Integral ABS Pro ensures directional stability on any surface. The system is not optimised for special requirements that apply under extreme competitive conditions off-road or on the track. The driving behaviour should be adapted to actual driving skills and the road conditions.

Special situations

The speeds of the front and rear wheels are compared as one means of detecting a wheel's incipient tendency to lock. If the system registers implausible values for a lengthy period the ABS function is

deactivated for safety reasons and an ABS fault message is issued. Self-diagnosis has to complete before fault messages can be issued.

In addition to problems with the BMW Motorrad ABS, exceptional riding conditions can lead to a fault message being issued:

- Heating up with the motorcycle on the centre stand or an auxiliary stand, engine idling or with a gear engaged.
- Rear wheel locked by the electrical machine's braking moment for a lengthy period, for example while descending on a loose or slippery surface.

If a fault message is issued on account of exceptional riding conditions, you can reactivate the ABS function by switching the ignition off and on again.

What significance devolves on regular servicing?



WARNING

Brake system not regularly serviced.

Risk of accident

- In order to ensure that the ABS is always maintained in optimum condition, it is essential for you to comply strictly with the specified inspection intervals.

Safety reserves

The potentially shorter braking distances which BMW Motorrad Integral ABS Pro permits must not be used as an excuse for careless riding. The system is primarily a means of ensuring a safety margin in genuine emergencies.



WARNING

Braking when cornering

Risk of accident despite ABS

- Invariably, the rider bears responsibility for assessing road and traffic conditions and adopting his or her style of riding accordingly.
- Do not take risks that would negate the additional margin of safety offered by this system.

Evolution of ABS to ABS Pro

Until now, BMW Motorrad ABS has helped ensure a very high degree of safety for braking with the motorcycle upright and travelling in a straight line. Now ABS Pro offers enhanced safety for braking in corners as well. ABS Pro prevents the wheels from locking even under sharp braking. ABS Pro reduces abrupt changes in steering force, particularly in shock-braking situations, counteracting the vehicle's otherwise natural but undesirable tendency to straighten up.

ABS intervention

Technically speaking, depending on the riding situation ABS Pro adapts ABS intervention to the motorcycle's bank angle. Signals for rate of roll and rate of yaw and lateral acceleration are used to calculate bank angle.

As the motorcycle is heeled over more and more as it banks into a corner, an increasingly strict limit is imposed on the brake-pressure gradient for the start of brake application. This slows the build-up of brake pressure to a corresponding degree. Additionally, pressure modulation is more uniform across the range of ABS intervention.

Advantages for the rider

The advantages of ABS Pro for the rider are sensitive response and high braking and directional stability combined with best-case deceleration of the motorcycle, even when cornering.

DYNAMIC TRACTION CONTROL (DTC)

How does traction control work?

Traction control compares the front and rear wheel circumferential velocities. The differential is used to compute slip as a measure of the reserves of stability available at the rear wheel. If slip exceeds a certain limit, the electrical machine management system intervenes and adapts torque accordingly. Dynamic Traction Control (DTC) takes bank angle into consideration and on account of this additional bank angle and acceleration data, its intervention is more precise and more comfortable for the rider.

BMW Motorrad DTC is designed as an assistant system for the rider and for use on public roads. The extent to which the rider affects DTC control can be considerable (weight shifts when cornering, items of luggage loose on the vehicle), especially when the style of riding takes rider and machine close to the limits imposed by physics.

Activate ENDURO riding mode for off-roading. This mode delays DTC intervention slightly in order to permit controlled drifting.

The system is not optimised for special requirements that apply under extreme competitive conditions off-road or on the track. The BMW Motorrad DTC can be deactivated in these cases.



WARNING

Risky riding

Risk of accident despite DTC

- Invariably, the rider bears responsibility for assessing road and traffic conditions and adopting his or her style of riding accordingly.
- Do not take risks that would negate the additional safety offered by this system.

Special situations

In accordance with the laws of physics, the ability to accelerate is restricted more and more as the angle of heel increases. Consequently, there can be a perceptible reduction in acceleration out of very tight bends.

If the electronic processor receives values for the bank angle that it considers implausible over a lengthy period, a dummy value is used for the bank angle or the DTC function is switched off. Under these circumstances the indicator for a DTC fault shows. Self-diagnosis has to complete before fault messages can be issued.

Traction control can shut down automatically under the exceptional riding conditions outlined below.

Exceptional riding conditions:

- Riding for a lengthy period with the front wheel lifted off the ground (wheelie).
- Rear wheel rotating with the vehicle held stationary by application of the front brake (burn-out).
- Heating up with the motorcycle on an auxiliary stand, in neutral or with a gear engaged.

If the front wheel lifts clear of the ground under severe acceleration, DTC either as a function of the riding mode or the DTC setting reduces engine torque until the front wheel regains contact with the ground.

178 ENGINEERING DETAILS

BMW Motorrad recommends turning the throttle grip back slightly when lifting the front wheel in order to reach a stable driving condition again as soon as possible.

DYNAMIC ENGINE BRAKE CONTROL (MSR)

How does dynamic engine brake control work?

The purpose of dynamic engine brake control is to prevent the unstable riding states that can be produced by excessive engine braking moment acting on the rear wheel. Depending on the road condition and riding dynamic, excessive braking torque can produce a sharp rise in rear-wheel slip and impair directional stability. Dynamic engine brake control limits this slip at the rear wheel to a safe mode-dependent and bank-angle-dependent regulated slip.

Causes for excessive slip at the rear wheel:

- Riding with engine overrun on a surface with a low coefficient of friction (e.g. wet leaves).
- Rear-wheel hop when rider downshifts.

–Sharp braking during sporty riding.

In the same way as DTC traction control, dynamic engine brake control compares the wheel circumferential velocities of the front and rear wheels. Additional information on the bank angle enables dynamic engine brake control to calculate slip and the reserve of stability at the rear wheel.

If slip overshoots the applicable limit, the throttle valves are opened very slightly to increase engine torque. Slip is reduced and the vehicle is stabilised.

BATTERY GUARD

What is the Battery Guard?

The Battery Guard monitors the battery's state of charge and battery voltage. The Battery Guard helps prevent deep discharge of the battery and enables appropriate recharging in accordance with the drain on the battery.

How does Battery Guard work?

As long as the vehicle is switched off, the state of charge or the voltage of the battery is checked once a day. If the system ascertains that the values measured in this way are too low, a warning message is issued after the ignition is switched on. Depending on the availability of BMW Motorrad Teleservices, warning messages can also be transmitted by electronic notification. More detailed information about the BMW Motorrad Teleservices is available from your authorised BMW Motorrad retailer.

Battery Guard has multi-stage reaction:

–**Low state of charge:** 12 V socket is activated. A charger connected to this socket can recharge the battery.

In combination with BMW Motorrad Teleservices:

–**Low state of charge:** Every three days, a warning message prompting for the battery to be recharged is transmitted.

–**Critical state of charge:** Every day, a warning message

prompting for the battery to be recharged is transmitted.

SHUTDOWN CONCEPT

What is the shutdown concept?

While the ignition is on, the electrical system voltage and the battery's state of charge are monitored. If so many electrical loads are active that power demand can no longer be covered by the alternator, the shutdown concept comes into play. Comfort functions are either downgraded or switched off in line with demand to ensure that vehicle operation can be maintained. In the event of a shutdown, a warning message appears in the instrument cluster.

The shutdown concept achieves the following:

- Stabilisation of the electrical system voltage
- Maintenance of a positive charge-discharge balance
- Less load on the 12 V on-board battery
- Less load on components and vehicle wiring harness

DISTANCE CONTROL (ACTIVE CRUISE CONTROL ACC)

What is ACC?

BMW Motorrad ACC is a cruise control system with approach distance control. The function enables the rider to set a preferred speed and a preferred approach distance from the vehicle directly ahead in the same lane. Cruising speed remains constant as long as the distance to the vehicle directly ahead is not shorter than the approach distance selected by the rider. As soon as the approach distance is less than this preset, speed is reduced until the distance between the two vehicles again matches the rider's preferred setting. Responsibility remains with the rider, who can intervene at any time and override the ACC. The ACC function has two characteristics: *Comfortable* and *Dynamic*. They affect acceleration and deceleration while control is actively intervening.

How does ACC work?

The front-mounted radar sensor detects vehicles travelling ahead. At the same time, the radar sensor analyses yaw rate and vehicle speed to calculate what is referred to as the prospective ride path, in other words the corridor along which the motorcycle will proceed over the next approx. 100 m approximately. If one of the detected objects is in this prospective ride path the system reacts accordingly, adapting speed so that the rider's preset approach distance from the object travelling ahead is maintained.

Control functions of ACC

ACC is divided into five control functions, as follows:

- Cruise control:** Cruising speed is adapted to the setting chosen by the rider.
- Distance control:** The vehicle cruises at the speed chosen by the rider, but speed is varied to maintain the selected approach distance to be maintained behind the vehicle in front.
- Cornering control:** When the vehicle corners speed is reduced if necessary and the system attempts to achieve a

comfortable bank angle (e.g. 20°). As bank angle increases, moreover, braking and acceleration dynamism is limited so that no sudden braking or acceleration takes the rider unawares. Cornering control prevents, for example, unexpected acceleration on object loss by the radar and when the rider's selected speed setting is inappropriately high. Object loss can occur when the vehicle head is only partly registered by the radar as a bend is negotiated.

- Passing assistant:** When a vehicle is present ahead, the rider can activate the passing assistant by switching on the indicators on the side appropriate for a passing manoeuvre. This causes the vehicle to pick up speed, accelerating into a fluid passing manoeuvre. If a passing manoeuvre does not take place the distance behind the vehicle ahead is closed up to some extent for a brief time.
- Passing prevention:** The ACC function prevents a vehicle for which no passing manoeuvre has been signalled from being overtaken. This

would apply, for example, to a vehicle that is on the left in right-hand traffic or a vehicle on the right in left-hand traffic. When a vehicle presence is detected in these circumstances the system settles accordingly to the appropriate distance behind. Briefly opening the throttle or indicating for a passing manoeuvre on the opposite side suppresses passing prevention.

Speed range of ACC

The ACC function can be activated in the following speed ranges:

- 30...160 km/h
- If ACC is activated in the speed range above 160 km/h, the maximum speed of 160 km/h is selected.

Influence on the performance of ACC

The rider can assist the performance of ACC by:

- Adopting a smooth style of riding.
- Staying as close as possible to the middle of lane behind the vehicle in front.
- When overtaking, making clear lane changes to the passing lane to help the system deselect the vehicle

182 ENGINEERING DETAILS

directly ahead in the original lane.

- Returning to the original lane as quickly as possible behind the next vehicle ahead, to allow the system time to select the reference object head.

FRONT COLLISION WARNING (FCW)

What is FCW?

BMW Motorrad FCW is an collision warning system that warns of critical situations in the lane traffic ahead and assists the rider to recognise and deal with these situations. The function warns of imminent collisions and assists with application of the brakes. Collision warnings are issued visually in the instrument cluster and haptically by warning pulses of the brakes. Collision warnings are two-stage, with an advance warning and an acute warning. The advance warning is issued at least in visual form, via the instrument cluster. If so configured in the menu, this is accompanied by a haptic warning in the form of a warning pulse (▣▣▣▣▶ 119). The warning pulse directs the rider's attention to the hazardous situation.

If the criticality of the situation increases, the second stage is issue of the acute warning. The acute warning is issued at least via the instrument cluster, in visual form. If so configured in the menu, the brake assistant bridges the rider's reaction time by a slight application of the brakes (▣▣▣▣▶ 119).

Timing of warning threshold

To determine when the rider should be warned, the system calculates how long the rider can continue to ride with the current dynamic before a controlled braking manoeuvre will become the only way to avoid a collision.

The warning thresholds can be moved slightly as a function of the rider's level of attentiveness. An attentiveness estimator evaluates both the current riding dynamic and the possible interactions of the rider with the motorcycle in order to gauge how attentively the rider is observing the traffic situation ahead.

The timing of the warning threshold can be set to **Early**, **Medium** and **Late**.

Speed range of FCW

The FCW can monitor traffic ahead and intervene in the following speed ranges:
–30...160 km/h

Interaction with ACC

FCW is implemented in such a way that during an approach manoeuvre with ACC active, no front collision warning is triggered. ACC reacts primarily to objects directly in lane ahead, so a vehicle swerving into the lane ahead can be evaluated as a critical object by FCW before ACC identifies it as a vehicle in front. Under these circumstances, with ACC active and a vehicle present ahead, a front collision warning might be triggered. FCW, unlike ACC, does not have to be reactivated for each ride.

LANE CHANGE WARNING (SWW)

What is lane change warning?

BMW Motorrad lane change warning monitors following traffic and notifies the rider of critical riding situations before a lane change.

How does lane change warning work?

When the rear radar sensor detects the presence of another road user in the neighbouring lane or approaching from behind in the blind spot beside and behind the vehicle, the rider is warned accordingly. A distinction is drawn between a notification and an acute warning. The system knows that a lane change is imminent when the rider activates the turn indicators and it issues an early warning to the rider if danger threatens. The warning zone gets bigger as speed differential increases, so that it can warn effectively of traffic approaching at speed.

Condition for lane change warning

Lane change warning is subject to the system conditions described below:

184 ENGINEERING DETAILS

- Range of rear radar:** The radar sensor has a maximum viewing range of approx. 80 m. Timely issue of a collision warning is possible up to a speed differential of 80 km/h relative to the approaching vehicle.
- Speed ranges:** Warning messages are issued as of speed ranges above 18 km/h and are sustained until speed drops to 15 km/h. In a passing manoeuvre, warning messages are issued as long as the speed differential relative to the passed vehicle is less than 15 km/h.
- Rear radar detection when cornering:** Radar detection is fully functional at bank angles up to 25 degrees.

DYNAMIC SUSPENSION ADJUSTMENT (DSA)

- with Dynamic Suspension Adjustment^{OE}

How does DSA work?

Dynamic Suspension Adjustment (DSA) is as semi-active suspension-adaptation system that reacts automatically to riding manoeuvres and to surface conditions. By interpreting ride height sensor signals, DSA de-

fects movements in the chassis and suspension and responds by adjusting the damper valves. Additionally, the suspension characteristic can be set up to suit the desired riding experience. This is accomplished by automatic adaptation of the spring rate in addition to the damping, depending on riding mode.

Load equalisation

DSA adapts the motorcycle automatically to the load it is carrying. The rider does not have to adjust the suspension to suit the load.

When driving off and when riding, the system monitors the suspension at the rear wheel and corrects the spring setting in order to set the correct riding position. The damping is also adjusted automatically to the load.

- with Adaptive Ride Height^{OE}
Ride height control

Adaptive ride height control automatically adapts ride height to the riding situation. After pullaway, the suspension changes to the high ride height. When the vehicle is brought to a stop the suspension automatically returns to the low

ride height, making it easier for the rider to put their feet on the ground.

Ride height can also be adjusted manually, depending on the riding mode.

Possible settings, ride height

- Auto: Automatic adjustment of ride height
- High: Permanently high ride height

In ENDURO and ENDURO PRO riding modes:

- Low: Permanently low ride height
- High: Permanently high ride height

-with Dynamic Suspension Adjustment^{OE}

Possible settings, damping

- Road: Damping for comfortable on-road riding
- Dynamic: Damping for dynamic on-road riding

In ENDURO and ENDURO PRO riding modes:

- Enduro: Damping for off-road riding

The damping characteristics can be adapted in 5 stages, allowing fine-tuning to suit individual preferences.

RIDING MODE

Selection

To adjust the motorcycle to the road condition and the desired driving experience, the following riding modes can be selected:

- ECO
- RAIN
- ROAD (default mode)
- ENDURO

-with riding modes Pro^{OE}

- DYNAMIC
- DYNAMIC PRO
- ENDURO PRO

A maximum of four riding modes can be preselected by means of the riding mode preselection function.

For each of these riding modes, there is a matching setting for the DTC, ABS and MSR systems and for the engine characteristic.

-with Dynamic Suspension Adjustment^{OE}

The adjustment of the DSA also depends on the riding mode selected.

186 ENGINEERING DETAILS

DTC can be switched off in each riding mode. The explanations below always refer to the dynamic safety systems that are switched on.

Throttle response

- In ECO riding mode: Restrained
- In RAIN and ENDURO riding modes: Soft
- In ROAD and ENDURO PRO riding modes: Optimum
- In DYNAMIC and DYNAMIC PRO riding modes: Direct
- In DYNAMIC PRO and ENDURO PRO riding modes, throttle response can be set up differently in SETUP (▶▶▶ 105).

ABS

 The default factory setting is ABS deactivated for the rear wheel when the ENDURO PRO riding mode is active.

Adjustment

- In ROAD, DYNAMIC, ENDURO and ENDURO PRO riding modes, the ABS setting corresponds to the individual riding mode.
- In ECO and RAIN riding modes, the ABS setting corresponds to the ROAD riding mode.

- In DYNAMIC PRO riding mode, the ABS setting corresponds to the DYNAMIC riding mode.
- In DYNAMIC PRO and ENDURO PRO riding modes, the ABS can be set up differently via SETUP (▶▶▶ 108).

Tuning setup

- In ECO, RAIN, ROAD, DYNAMIC and DYNAMIC PRO riding modes, the ABS is set up for on-road riding.
- In ENDURO riding mode, the ABS is set up for off-road riding with road tyres.
- In ENDURO PRO riding mode, there is no ABS control at the rear wheel when the foot-brake lever is operated. The ABS is set up for off-road riding with cleated tyres.

Rear-wheel lift-off detection

- In ECO, RAIN and ROAD riding modes, the rider has maximum assistance from rear-wheel lift-off detection.
- In DYNAMIC, DYNAMIC PRO and ENDURO riding modes, rear-wheel lift-off detection offers reduced assistance and allows slight lift-off of the rear wheel.
- In ENDURO PRO riding mode, rear wheel lift-off detection is inactive.

ABS Pro

- In ECO, RAIN and ROAD riding modes, ABS Pro is fully available.
- In DYNAMIC, DYNAMIC PRO and ENDURO riding modes, ABS Pro assistance is reduced by comparison with ECO, RAIN and ROAD riding modes.
- In the standard setup of ENDURO PRO riding mode, ABS Pro is not available.

Brake force distribution**Application of the front wheel brake**

- In ECO, RAIN and ROAD riding modes, maximum possible brake force is distributed to the rear wheel.
- In DYNAMIC and DYNAMIC PRO riding modes, less brake force is distributed to the rear wheel than in ECO, RAIN and ROAD modes.
- In ENDURO riding mode, less brake force is distributed to the rear wheel and brake force distribution is optimised for offroad riding.
- In ENDURO PRO riding mode, maximum brake force is distributed to the rear wheel and brake force distribution is optimised for offroad riding.

Actuation of the rear brake

- In ECO, RAIN and ROAD riding modes, maximum possible brake force is distributed to the front wheel.
- In DYNAMIC and DYNAMIC PRO riding modes, riding modes, less brake force is distributed to the front wheel than in ECO, RAIN and ROAD modes.
- In ENDURO riding mode, less brake force is distributed to the front wheel and brake force distribution is optimised for offroad riding.
- In ENDURO PRO riding mode, brake force distribution is inactive.

DTC**Tyres**

- In RAIN, ROAD, DYNAMIC and DYNAMIC PRO riding modes, DTC is set up for on-road riding with road tyres.
- In ENDURO riding mode, DTC is set up for off-road riding with road tyres.
- In ENDURO PRO riding mode, DTC is set up for off-road riding with cleated tyres.

The following steps must be taken to change the riding mode:

- Close the throttle twistgrip.
- Release the brake levers.
- Deactivate cruise control.

The desired riding mode is initially preselected. The mode change does not take place until the systems in question are all in the appropriate state.

The selection menu does not disappear from the display until the mode change has taken place.

ECO mode

ShiftCam technology is the bridge-builder between ultra-high dynamism and maximum efficiency. The full-load cams allow full valve lift for maximum combustion-chamber charge and high power, whereas the part-load cams considerably shorten the lift of the intake valves and open the valves to different extents. Charge-cycle losses are lessened by de-throttling, friction is reduced, the mixture is swirled more vigorously and combusted more effectively, fuel consumption goes down.

The ECO mode assists the rider with ECO indicator and

engine characteristic (parametrisation of the electromotive throttle controller) to keep the engine in the operating range of the consumption-oriented part-load cam, so as to maximise the distance travelled with a given quantity of fuel.

The length of the green bar in the ECO indicator in the instrument cluster visualises whether the drive is operating in the consumption-optimised range of the part-load cam and the margin from the switch-over threshold to full-load cam operation. The length of the bar represents the load reserve left before the switch-over point for full-load cam operation is reached. The colour changes to grey when load requirement increases and the engine switches to the full-load cam. The reading shown by the ECO indicator varies depending on the gear selected by the rider, the load requirement input via the throttle grip, and engine rpm.

Rider can further reduce consumption by riding with fuel economy in mind (▣▶ 195).

DYNAMIC BRAKE CONTROL

How Dynamic Brake Control works



The Dynamic Brake Control function is active in all riding modes. It can be deactivated in the DYNAMIC PRO and ENDURO PRO riding modes only, by custom parametrisation of the ABS.

The Dynamic Brake Control function assists the rider in emergency braking situations.

Detection of emergency braking

– Sudden, sharp application of the front brake is interpreted as emergency braking.

Behaviour in emergency braking

- If emergency braking occurs at a speed in excess of min 10 km/h, the ABS function is further assisted by Dynamic Brake Control.
- When partially integral braking at a high brake pressure gradient is initiated, Dynamic Brake Control increases the integral brake pressure at the rear wheel. The stopping distance shortens and controlled braking is possible.

Behaviour during accidental actuation of the throttle grip

- If the throttle is accidentally opened (throttle grip position $> 5\%$) during emergency braking, Dynamic Brake Control ensures the desired braking effect by ignoring actuation of the throttle grip. The effectiveness of emergency braking is ensured.
- If the throttle is closed (throttle grip position $< 5\%$) while Dynamic Brake Control is in action, the engine torque requested by the ABS brake system is restored.
- If emergency braking ceases and the rider still has not changed the position of the throttle grip, Dynamic Brake Control steadily ramps engine torque back to the rider's requested level.

TYRE PRESSURE CONTROL (RDC)

Function

A sensor integrated into each tyre measures the air temperature and the air pressure inside the tyre and transmits this information to the control unit. Each sensor has a centrifugal-force tripswitch that does not enable transmission of the

measured values until the motorcycle has accelerated to a defined minimum speed for the first time.



Minimum speed for transmission of the RDC measured values:

min 30 km/h

The display shows -- for each tyre until the tyre-pressure signal is received for the first time. The sensors continue to transmit the measured-value signals for some time after the vehicle comes to a stop.



Time for transmission of measured values after vehicle comes to a stop:

min 15 min

An error message is issued if wheels without sensors are fitted to a vehicle equipped with an RDC control unit.

Tyre pressure ranges

The RDC control unit distinguishes between three tyre pressure ranges matched to the vehicle:

- Filling pressure within the permissible tolerance
- Filling pressure in the limit range of the permissible tolerance

- Filling pressure outside permitted tolerance

Temperature compensation

Tyre pressure is a temperature-sensitive variable: pressure increases as tyre-air temperature rises and decreases as tyre-air temperature drops. Tyre air temperature depends on ambient temperature as well as on the style of riding and the duration of the ride.

The tyre-pressure readings in the multifunction display are temperature-compensated and are always referenced to a tyre-air temperature of 20 °C.

The air lines available to the public in petrol stations and motorway service areas have gauges that do not compensate for temperature; the reading shown by a gauge of this nature is the temperature-dependent tyre-air pressure. As a result, the values displayed there usually do not correspond to the values displayed in the display.

192 ENGINEERING DETAILS

Pressure adaptation

Compare the RDC value in the instrument cluster with the value in the table on the back cover of the rider's manual. Then use the air-line gauge at a service station to compensate for the difference between the RDC reading and the value in the table.

 Example
According to the operating instructions, the tyre pressure should be:
2.5 bar
The instrument cluster shows the following value:
2.3 bar
So pressure is low by:
0.2 bar
The gauge on the air line shows:
2.4 bar
You must now increase tyre pressure until the value is:
2.6 bar

GEAR SHIFT ASSISTANT

–with shift assistant Pro^{OE}

Gear Shift Assistant Pro

Your vehicle is equipped with Gear Shift Assistant Pro, a system originally developed for racing and now adapted for the touring sector. It permits upshifts and downshifts without declutching or closing the throttle in virtually all load and rpm ranges.

The engine control system supports gear changes as a function of:

- Required gear
- Engine rpm
- Position of the throttle twist-grip

The rider bears responsibility for use of the shift assistant and must take the riding situation and safety and comfort aspects duly into consideration.

Advantages

- A large proportion of gearshifts can be carried out without using the clutch.
- Less relative movement between rider and passenger because the shift pauses are shorter.

- It is not necessary to close the throttle twistgrip when shifting under acceleration.
- When downshifting (throttle twistgrip closed), engine speed is adjusted by blipping the throttle.
- Shift time is shorter than a gearshift with clutch actuation.

The rider indicates a gearshift request by moving the gearshift lever from what was an untouched position at normal to snappy speed in the appropriate direction and following this movement through to the mechanical limit position of the gearshift operation. Once the gearshift has completed the shift lever has to be fully released before another gearshift with the Pro shift assistant can take place. In order to optimise shift quality when shifting gears with the Gear Shift Assistant Pro, the rider has to keep load state (throttle twistgrip position) constant before and during the gearshift. The Gear Shift Assistant Pro provides no assistance for gearshifts when the rider declutches.

Downshifting

- Downshifting is assisted until maximum rpm for the target gear to be selected is reached. This prevents over-revving.



Maximum engine speed

max 9000 min⁻¹

Upshifting

- Upshifting is assisted until engine speed is below idle rpm in the target gear. This prevents the engine from dropping below idle speed.
- On account of the operating principle, a certain loss of comfort and perceptibly sharper load-change reactions can be experienced if the system is used for upshifts on overrun, particularly in low gears.

HILL START CONTROL (HSC)

How Hill Start Control works

Hill Start Control is a pullaway assistant that operates on the integral ABS-system to prevent the vehicle from rolling back on a gradient, without the rider having to keep pressure applied to the brake lever. When Hill Start Control is activated,

194 ENGINEERING DETAILS

pressure is built up in the rear brake system to keep the machine at a standstill on a gradient.

The brake pressure in the brake system is dependent on the gradient.

Effect of an incline on brake pressure and drive-off behaviour

- If the motorcycle is stopped on a gentle incline, only low brake pressure is built up. In this case, the brakes are quickly released when driving off. The motorcycle can be moved off more gently. It is not necessary to turn the throttle grip again.
- If the motorcycle is stopped on a steep incline, high brake pressure is built up. In this case, the brakes take longer to release when driving off. More torque is required for driving off which also requires the rider to turn the throttle grip again.

Behaviour when the motorcycle rolls or slips

- If the vehicle starts to roll while Hill Start Control is active, brake pressure is increased.

- If the rear wheel slips, the brake is released again after approx. 1 m. This prevents the vehicle slipping with a locked rear wheel, for example.

Brake release when engine is stopped or after time-out

Hill Start Control is deactivated if the rider stops the engine by hitting the emergency-off switch (kill switch) or when the side stand is extended, or after time-out (10 minutes).

In addition to the indicator and warning lights, the rider should be made aware that Hill Start Control has been deactivated by the following behaviour:

Brake warning jolt

- The brake is released briefly and reactivated immediately.
- This creates a jolt which the rider feels.
- The integral ABS brake system limits the speed of movement to approx. 1...2 km/h.
- The rider must brake the motorcycle manually.
- After two minutes, or when the brake is actuated, Hill Start Control is completely deactivated.

 The holding pressure is released immediately without a brake warning jolt as soon as the ignition is switched off.

SHIFTCAM

Functional principle of ShiftCam

The vehicle features BMW ShiftCam technology for varying valve timing and valve lift on the intake side. The heart of this technology is a one-piece shifting intake camshaft that has two lobes for each valve: a partial-load cam and a full-load cam. The partial-load cam is fine-tuned for consumption optimisation and engine smoothness. As well as adapting valve timing, the partial-load cam also reduces intake-valve lift. With the partial-load cams activated, moreover, the lobes for the cylinder's left and right intake valves produce staggered valve lift and offset angles of rotation. Consequently the two intake valves open at very slightly different times and the distance to which they open also differs. The advantage: The fuel/air mixture flowing into the combustion chamber is

swirled more thoroughly and combusted effectively - so all in all the fuel is utilised more efficiently and engine operation is perceptibly smoother. The full-load cam is designed for optimised engine power and it maximises intake valve lift. The intake camshaft is shifted axially to vary valve timing and valve lift. The pins of an electromechanical actuator engage a shift gate on the intake camshaft. This permits load-dependent and speed-dependent actuation of the intake valves and, consequently, a no-compromises combination of performance and low fuel consumption.

CORNERING HEADLIGHT

—with Headlight Pro^{OE}

How does the additive cornering headlight work?

In addition to the bulbs for low beam, high beam and, if applicable, daytime riding light or side light, the headlight has separate LED segments for the cornering light. The LED segments are activated as a function of bank angle in addition to the low-beam headlight, enabling the headlight to illuminate the inside of the bend as

196 ENGINEERING DETAILS

the motorcycle banks for cornering.

MAINTENANCE

09

GENERAL NOTES	200
TOOLKIT	201
FRONT-WHEEL STAND	201
REAR-WHEEL STAND	202
ENGINE OIL	202
BRAKE SYSTEM	204
CLUTCH	209
COOLANT	209
TYRES	210
WHEEL RIMS	212
WHEELS	212
AIR FILTER	220
SIDE PANEL	221
LIGHTING	223
JUMP-STARTING	223
BATTERY	225
FUSES	231
DIAGNOSTIC CONNECTOR	233

200 MAINTENANCE

GENERAL NOTES

The Maintenance chapter describes straightforward procedures for checking and replacing certain wear parts.

Special tightening torques are listed as applicable. The tightening torques for the threaded fasteners on your vehicle are listed in the section entitled "Technical data".

Some of the work calls for special tools and a thorough knowledge of the technology involved. If in doubt consult a specialist workshop, preferably an authorised BMW Motorrad retailer.

Microencapsulated screws

The microencapsulation is a chemical thread-locker. An adhesive compound creates a secure connection between bolt and nut or between screw and component. Consequently, microencapsulated screws are for once-only use and are not intended for re-installation after being slackened.

Regardless of whether the procedure involves removal or installation, the threaded bore always has to be cleaned. After removal of the screw, clean the

internal thread to remove all traces of thread-locking compound. Always use new microencapsulated screws when re-assembling. Prior to disassembly make sure that you have suitable tools for cleaning the threads and a new replacement for each screw to be removed. If the job is not done correctly there is no guarantee that the screw will remain secure, which means that you would be putting yourself at risk!

Non-reusable cable ties

Non-reusable cable ties are used at some points to secure cables and lines. To prevent damage to cables and lines when these items are being removed, it is essential to use a suitable tool, for example diagonal cutting pliers, for their removal.

Cables and lines detached beforehand by the removal of non-reusable cable ties have to be re-secured with new non-reusable cable ties.

Use cable-tie clippers to clip off the excess length of the cable ties.

TOOLKIT

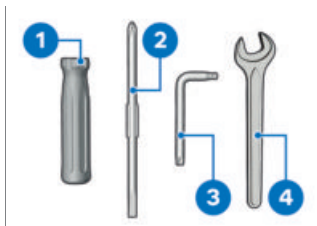

- 1 Screwdriver handle
-Use with screwdriver insert
- 2 Reversible screwdriver blade
With star-head and plain-tip ends
-Disconnect the battery from the motorcycle. (▶▶▶ 227)
- 3 Torx wrench, T25/T30
T25 on short end, T30 on long end
-Remove the right side panel. (▶▶▶ 221)
-Adjust the gearshift lever peg. (▶▶▶ 140)
-Adjust headlight beam throw. (▶▶▶ 139)
- 4 Open-ended spanner
Width across flats 14 mm

- 4 -without Dynamic Suspension Adjustment^{OE}
-Adjust the spring preload for rear wheel. (▶▶▶ 145)
-Adjust the mirror arm. (▶▶▶ 138)

FRONT-WHEEL STAND

Install the front-wheel stand



ATTENTION

Use of the BMW Motorrad front-wheel stand without accompanying use of centre stand or auxiliary stand

Risk of damage to parts if vehicle topples

- Place the motorcycle on its centre stand or another auxiliary stand before lifting the front wheel with the BMW Motorrad front-wheel stand.
- Make sure the motorcycle is standing firmly.
- Place the motorcycle on an auxiliary stand; BMW Motorrad recommends the BMW Motorrad rear-wheel stand.
- Install the rear-wheel stand. (▶▶▶ 202)

202 MAINTENANCE

–with centre stand^{OE}

- Make sure the ground is level and firm and place the motorcycle on its centre stand.◁



- See the instructions issued with the front-wheel stand for the details of the correct procedure for installation.
- BMW Motorrad offers an auxiliary stand suitable for every vehicle. Your BMW Motorrad retailer will be happy to help you with the selection of a suitable auxiliary stand.

REAR-WHEEL STAND

Install the rear-wheel stand



- The description of how to fit the rear-wheel stand correctly will be found in the instructions for the stand.
- BMW Motorrad offers an auxiliary stand suitable for every vehicle. Your BMW Motorrad retailer will be happy to help you with the selection of a suitable auxiliary stand.

ENGINE OIL

Checking engine oil level

 As a contribution to reducing environmental impact, BMW Motorrad recommends checking the engine oil on occasion after a trip of at least min 50 km.

ATTENTION

Misinterpretation of oil level reading, because oil level is temperature-dependent (the higher the temperature, the higher the oil level)

Engine damage due to incorrect oil filling

- Check the oil level only after a lengthy ride or when the engine is at operating temperature.
- Allow the engine to idle until the fan cuts in.
- Hold the motorcycle upright with the engine idling for at least 20 seconds, then switch off the engine.

 For the engine oil level reading to be correct the vehicle must be standing upright with both wheels on the ground, ready to ride. Do not place the motorcycle on its centre stand or an assembly stand.

- Wait for one minute to allow the oil to drain into the oil reservoir.
- Keep holding the motorcycle upright.

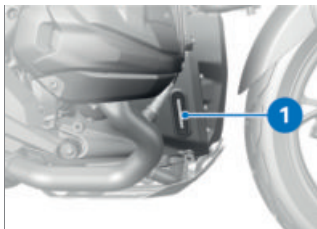



ATTENTION

Vehicle toppling sideways

Risk of damage to parts if vehicle topples

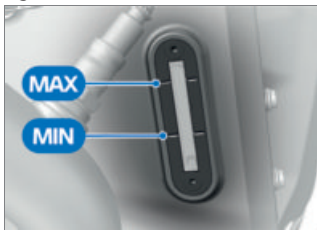
- Secure the vehicle, preferably with the assistance of a second person, so that it cannot topple sideways.
- Check the oil level in sight glass **1**.



 Engine oil, specified level

Between **MIN** and **MAX** marks

204 MAINTENANCE

If the oil level is below the **MIN** mark:

- Topping up the engine oil.
( 204)

If the oil level is at the top edge of sight glass **1**:

- Have the oil level corrected by a specialist workshop, preferably an authorised BMW Motorrad retailer.

Topping up engine oil

- Make sure the ground is level and firm and place the motorcycle on its stand.
- Wipe the area around the oil filler opening clean.



- Remove cap **1** of the oil filler opening.



ATTENTION

Use of insufficient engine oil or too much engine oil

Engine damage due to incorrect oil filling

- Always make sure that the engine oil level is correct.
- If the oil level is below the **MIN** mark max 0.5 l top up the engine oil.
- Install cap **1** of the oil filler opening.
- Check the engine oil level.
( 202)

BRAKE SYSTEM

Check operation of the brakes

- Pull the handbrake lever.
 - » The pressure point must be clearly perceptible.
- Press the footbrake lever.
 - » The pressure point must be clearly perceptible.

If pressure points are not clearly perceptible:

ATTENTION

Work on brake system not in compliance with correct procedure

Risk to operational reliability of the brake system

- Have all work on the brake system undertaken by trained and qualified specialists.

- Have the brakes checked by a specialist workshop, preferably an authorised BMW Motorrad retailer.

Checking brake pad thickness, front brakes

- Make sure the ground is level and firm and place the motorcycle on its stand.



- Visually inspect the left and right brake pads to ascertain their thickness. Viewing direction: Between wheel

and front suspension toward brake pads **1**.

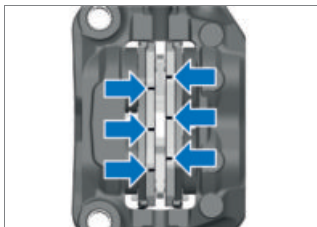

 Brake-pad wear limit, front

1.0 mm (Friction pad only, without backing plate. The wear indicators (grooves) must be clearly visible.)

If the wear indicating marks are no longer clearly visible:

WARNING

Brake-pad thickness less than permissible minimum

Diminished braking effect, damage to the brakes

- In order to ensure the dependability of the brake system, do not permit the brake pads to wear past the minimum permissible thickness.

- Have the brake pads replaced by a specialist workshop,

206 MAINTENANCE

preferably an authorised BMW Motorrad retailer.

Checking brake pad thickness, rear brakes

- Make sure the ground is level and firm and place the motor-cycle on its stand.



- Visually inspect the brake pads to ascertain their thickness. Viewing direction: Between spray guard and rear wheel toward brake pads **1**.
- Alternatively: From the right side of the vehicle, between rear wheel from below toward brake pads **1**.

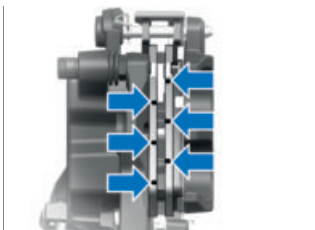

 Brake-pad wear limit, rear

1.0 mm (Friction pad only, without backing plate. The wear indicators (grooves) must be clearly visible.)

If the wear limit has been reached:

WARNING

Brake-pad thickness less than permissible minimum

Diminished braking effect, damage to the brakes

- In order to ensure the dependability of the brake system, do not permit the brake pads to wear past the minimum permissible thickness.

- Have the brake pads replaced by a specialist workshop, preferably an authorised BMW Motorrad retailer.

Checking brake-fluid level, front brakes



WARNING

Not enough brake fluid in brake fluid reservoir, or contaminants in brake fluid

Considerably reduced braking power due to presence of air, contaminants or water in the brake system

- Cease operation of the vehicle immediately and do not ride it until the fault has been rectified.
 - Check the brake-fluid levels at regular intervals.
 - Always make sure that the lid of the brake fluid reservoir and the area around the lid are cleaned before opening.
 - Make sure that only fresh brake fluid from a sealed container is used.
-
- Make sure the ground is level and firm and hold the motorcycle upright.
—with centre stand^{OE}
 - Make sure the ground is level and firm and place the motorcycle on its centre stand.◁
 - Move the handlebars to the straight-ahead position.



- Check the brake fluid level in brake fluid reservoir for front wheel brake **1**.



Wear of the brake pads causes the brake fluid level in the reservoir to sink.



Brake fluid level, front

Brake fluid, DOT4

It is not permissible for the brake fluid level to be below the **MIN** mark. (Brake-fluid reservoir horizontal, motorcycle upright)

208 MAINTENANCE

If the brake fluid level drops below the permitted level:

- Have the fault rectified as quickly as possible by a specialist workshop, preferably an authorised BMW Motorrad retailer.

Checking brake-fluid level, rear brakes

WARNING

Not enough brake fluid in brake fluid reservoir, or contaminants in brake fluid

Considerably reduced braking power due to presence of air, contaminants or water in the brake system

- Cease operation of the vehicle immediately and do not ride it until the fault has been rectified.
- Check the brake-fluid levels at regular intervals.
- Always make sure that the lid of the brake fluid reservoir and the area around the lid are cleaned before opening.
- Make sure that only fresh brake fluid from a sealed container is used.

- Make sure the ground is level and firm and hold the motorcycle upright.

–with centre stand^{OE}

- Make sure the ground is level and firm and place the motorcycle on its centre stand.◁

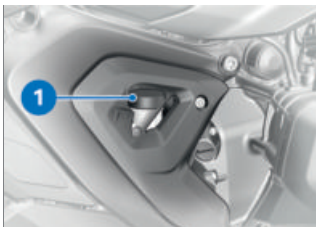

ATTENTION

Vehicle toppling sideways

Risk of damage to parts if vehicle topples

- Secure the vehicle, preferably with the assistance of a second person, so that it cannot topple sideways.
 - Check the brake fluid level in brake fluid reservoir for rear wheel brake **1**.
-  Wear of the brake pads causes the brake fluid level in the reservoir to sink.



Brake fluid level, rear

Brake fluid, DOT4

It is not permissible for the brake fluid level to be below the **MIN** mark. (Brake-fluid reservoir horizontal, motorcycle upright)

If the brake fluid level drops below the permitted level:

- Have the fault rectified as quickly as possible by a specialist workshop, preferably an authorised BMW Motorrad retailer.

CLUTCH

Checking operation of the clutch

- Pull the clutch lever.
 - » The pressure point must be clearly perceptible.

If the pressure point is not clearly perceptible:

- Have the clutch checked by a specialist workshop, preferably an authorised BMW Motorrad retailer.

COOLANT

Check the coolant level

- Make sure the ground is level and firm and place the motorcycle on its stand.
- Allow the motor to cool down.



- Check the coolant level in expansion tank **1**.

210 MAINTENANCE



Specified coolant level

Between **MIN** and **MAX** marks on the expansion tank (Engine cold)

If the coolant drops below the permitted level:

- Top up the coolant.

Topping up coolant



WARNING

Opening radiator cap

Risk of burning

- Do not open the radiator cap when the system is hot.
 - Check and, if necessary, top up the coolant in the expansion tank only.
-
- Remove the rider's seat. (▮▮▮ 134)
 - Remove the right side panel. (▮▮▮ 221)

- Open cap of expansion tank **1**.
- Top up coolant to the specified level using a suitable funnel.
- Check the coolant level. (▮▮▮ 209)
- Close cap of expansion tank **1**.
- Install the right side panel. (▮▮▮ 222)
- Install the rider's seat. (▮▮▮ 135)

TYRES

Checking tyre pressures



WARNING

Incorrect tyre pressure

Impaired handling characteristics of the motorcycle, shorter useful tyre life

- Always check that the tyre pressures are correct.

**WARNING****Tendency of valve inserts installed vertically to open by themselves at high riding speeds**

Sudden loss of tyre pressure

- Install valve caps fitted with rubber sealing rings and tighten firmly.
- Make sure the ground is level and firm and place the motorcycle on its stand.
- Check tyre pressures against the data below.



Tyre pressure, front

2.5 bar (tyre cold)



Tyre pressure, rear

2.9 bar (tyre cold)

If tyre pressure is too low:

- Correct tyre pressure.



Tyre pressures can be determined with tyre pressure control (RDC). The tyre-pressure readings shown in the instrument cluster are temperature-compensated and are always referenced to a tyre air temperature of 20 °C. The gauges on forecourt air lines do not compensate for tem-

perature. Consequently, the values they show do not usually tally with the pressure readings shown by the instrument cluster.

Check the tyre tread depth**WARNING****Riding with badly worn tyres**

Risk of accident due to impaired handling

- If applicable, have the tyres changed in good time before they wear to the minimum tread depth permitted by law.
- Make sure the ground is level and firm and place the motorcycle on its stand.
- Measure the tyre tread depth in the main tread grooves with wear marks.



Each tyre has wear indicators integrated into the main tread grooves. The tyre has reached its wear limit when the tread has worn down to the level of the wear indicators. The locations of the marks are indicated on the edge of the tyre, e.g. by the letters TI, TWI or by an arrow.

212 MAINTENANCE

If the tyre tread is worn to minimum:

- Replace tyre or tyres, as applicable.

WHEEL RIMS

Checking rims

- Make sure the ground is level and firm and place the motorcycle on its stand.
- Visually inspect the rims for defects.
- If damage is suspected, have the rims checked and, if necessary, replaced by a specialist workshop, preferably an authorised BMW Motorrad retailer.

Check the spokes

- with cross-spoked wheels^{OE}
or
—with cross-spoked wheels II^{OE}
- Make sure the ground is level and firm and place the motorcycle on its stand.
 - Draw the handle of a screwdriver or a similar instrument across the spokes and listen to the sequence of sounds made by the individual spokes.

If there is a variation in the sequence of sounds:

- Have the spokes checked by a specialist workshop, preferably an authorised BMW Motorrad retailer.

WHEELS

Effect of wheel size on chassis and suspension control systems

Wheel size is very important as a parameter for the ABS running-gear control system. In particular, the diameter and the width of a vehicle's wheels are programmed into the control unit and are fundamental to all calculations. Any change in these influencing variables, caused for example by a switch to wheels other than those installed ex-works, can have serious effects on the performance of the control systems.

The sensor rings are essential for correct road-speed calculation, and they too must match the motorcycle's control systems and consequently cannot be changed.

If you decide that you would like to fit non-standard wheels to your motorcycle, it is very important to consult a specialist workshop

beforehand, preferably an authorised BMW Motorrad retailer. In some cases, the data programmed into the control units can be changed to suit the new wheel sizes.

Removing front wheel

- Place the motorcycle on an auxiliary stand; BMW Motorrad recommends the BMW Motorrad rear-wheel stand.
- Install the rear-wheel stand. (→ 202)
- with centre stand^{OE}
- Make sure the ground is level and firm and place the motorcycle on its centre stand.◁

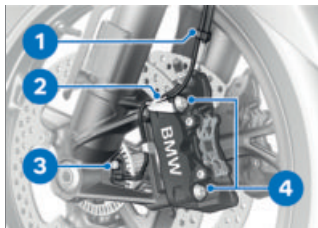

- Disengage the cable for the wheel speed sensor from holding clips **1** and **2**.
- Remove screw **3** and remove the wheel speed sensor from its bore.
- Mask off the parts of the wheel rim that could be

scratched in the process of removing the brake calipers.

ATTENTION

Unwanted inward movement of the brake pads

Component damage on attempt to install the brake caliper or because brake pads have to be forced apart

- Do not operate the brakes with a brake caliper not correctly secured.
- Remove mounting bolts **4** of the left and right brake calipers.

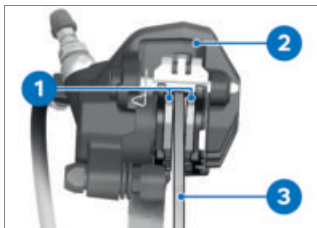

- Force brake pads **1** slightly apart by rocking brake caliper **2** back and forth against brake disc **3**.
- Carefully pull the brake calipers back and out until clear of the brake discs.

214 MAINTENANCE

- Lift the front of the motorcycle until the front wheel is clear of the ground, preferably using a BMW Motorrad front-wheel stand.
- Install the front-wheel stand. (▶▶▶ 201)

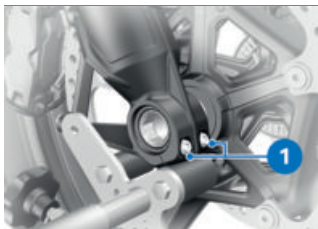

- Slacken right axle clamping screws **1**.



- Slacken left axle clamping screws **2**.
- Remove screw **1**.
- Press quick-release axle slightly toward the inside, so as to be better able to grip it on the right-hand side.

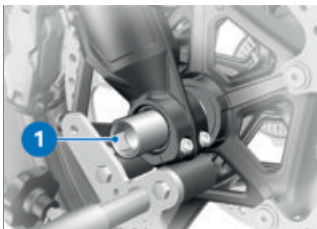

- Withdraw quick-release axle **1**, support the front wheel when doing this.
- Set down front wheel and roll forwards out of the front suspension.



- Remove spacer bushing **1** from the wheel hub.

Installing front wheel

WARNING

Use of a non-standard wheel

Malfunctions in operation of ABS and DTC

- See the information on the effect of wheel size on the ABS and DTC systems at the start of this chapter.

ATTENTION

Tightening threaded fasteners to incorrect tightening torque

Damage, or threaded fasteners work loose

- Always have the security of the fasteners checked by a specialist workshop, preferably an authorised BMW Motorrad dealer.



- Lubricate the friction face of spacer bushing **1**.



Lubricant

Unirex N3

- Insert spacer bushing **1** into the wheel hub on the left-hand side.

ATTENTION

Front wheel installed wrong way round

Risk of accident

- Note direction-of-rotation arrows on tyre or rim.
- Roll the front wheel into position between the forks of the front suspension.

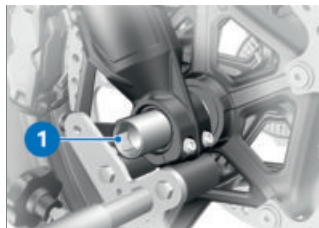

- Lubricate quick-release axle **1**.



Lubricant

Unirex N3

- Lift the front wheel slightly and install quick-release axle **1**.

216 MAINTENANCE

- Remove front-wheel stand and firmly compress front forks several times. Do not operate the brake in this process.
- Install the front-wheel stand. (▶▶ 201)

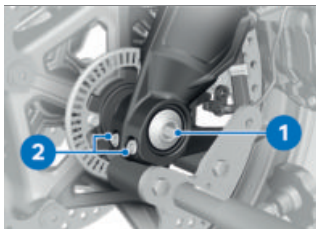

- Install screw **1** and tighten to specified torque. In this process, counter-hold the quick-release axle on the right side.



Screw in quick-release axle

M20 x 1.5

50 Nm

- Tighten left axle clamping screws **2** to the specified torque.



Clamping screws for quick-release axle

Tightening sequence: Tighten screws six times in alternate sequence

M6 x 30 - 10.9

12 Nm

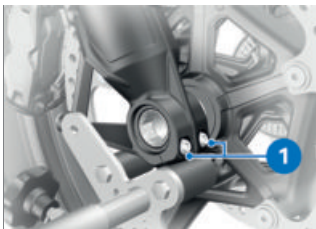

- Tighten right axle clamping screws **1** to the specified torque.



Clamping screws for quick-release axle

Tightening sequence: Tighten screws six times in alternate sequence

M6 x 30 - 10.9

12 Nm

- Remove the front-wheel stand.
- Position left and right brake calipers on the brake discs.

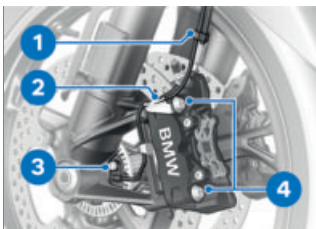

- Install securing screws **4** on left and right and tighten to specified tightening torque.



Radial brake caliper on telescopic forks

M10 x 60

38 Nm

- Remove the adhesive tape from the wheel rim.



WARNING

Brake pads not lying against the brake disc

Risk of accident due to delayed braking effect.

- Before driving, check that the brakes respond without delay.
- Operate the brake several times until the brake pads are bedded.
- Insert the cable for the wheel speed sensor into holding clips **1** and **2**.
- Insert the wheel speed sensor into the bore hole and install screw **3**.



Wheel-speed sensor to fork leg

M6 x 16

Joining compound: Micro-encapsulated

8 Nm

Removing rear wheel

–with off-road tyres^{OE}

- Make sure the ground is level and firm and place the motorcycle on its stand.

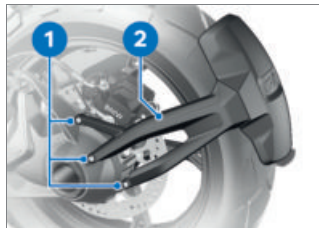

- Remove screws **1**.
- Remove spray guard **2**.◁
- Place the motorcycle on an auxiliary stand; BMW Motorrad recommends the BMW Motorrad rear-wheel stand.
- Install the rear-wheel stand. (▮▮▮▶ 202)
–with centre stand^{OE}
- Make sure the ground is level and firm and place the motorcycle on its centre stand.◁



CAUTION

Hot exhaust system

Risk of burn injury

- Do not touch a hot exhaust system.

218 MAINTENANCE

- Allow rear silencer to cool down.
- with double silencer^{OE}

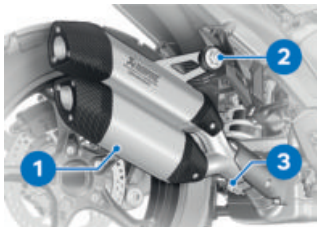

- Slacken clamp **3**.
- Remove the screw with shaped washer **2**.
- Remove silencer **1** and clamp **3**.

 The clamp is designed for one-time installation only and has to be replaced before the silencer is installed.◁



- Remove bolts **1** from the rear wheel, while supporting the wheel.
- Tilt the rear wheel to the side to remove.

Installing rear wheel

WARNING

Use of a non-standard wheel

Malfunctions in operation of ABS and DTC

- See the information on the effect of wheel size on the ABS and DTC systems at the start of this chapter.

ATTENTION

Tightening threaded fasteners to incorrect tightening torque

Damage, or threaded fasteners work loose

- Always have the security of the fasteners checked by a specialist workshop, preferably an authorised BMW Motorrad dealer.

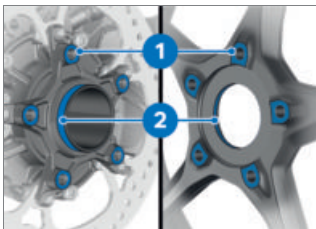

- Clean the contact surfaces of wheel hub **1** and wheel centring sigot **2**.

- Seat the rear wheel on the rear-wheel adapter.



- Install wheel bolts **1** and tighten to specified torque.

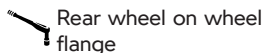

Tightening sequence: tighten in diagonally opposite sequence

M10 x 1.25

60 Nm

–with double silencer^{OE}

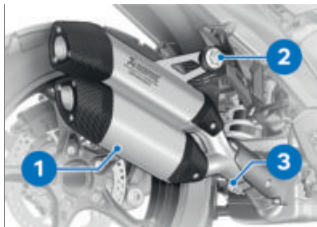

- Lightly lubricate the inner face of new clamp **3**.



Optimoly TA

- Slide new clamp **3** on to silencer **1**.
- Push silencer **1** to the limit position.
- Install the screw with shaped washer **2**.

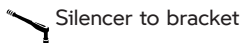

M8 x 35

19 Nm ◁

–with double silencer^{OE}

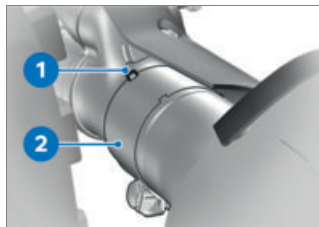

- Position the clamp with recess **2** in retaining lug **1**.
» Retaining lug **1** engages in the recess in the clamp.
- Tighten the clamp with recess **2**.

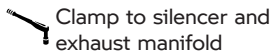

Joining compound: Lubricate inner face of clamp, Optimoly TA

220 MAINTENANCE

 Clamp to silencer and exhaust manifold

22 Nm \triangleleft

–with off-road tyres^{OE}

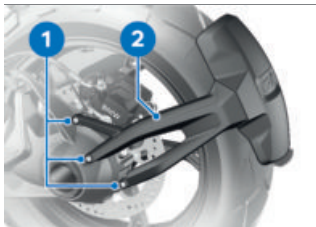

- Clean the threads for screws **1**.
- Hold spray guard **2** in position.
- Install screws **1**.

 Spray guard to bevel gears

M6 x 20

Thread-locking compound:
micro-encapsulated

8 Nm \triangleleft

AIR FILTER

Removing air filter element

 The procedure described here for the air filter on the right side applies by analogy for the air filter on the left side as well.

- Remove the rider's seat.
(\Rightarrow 134)

- Remove the right side panel.
(\Rightarrow 221)

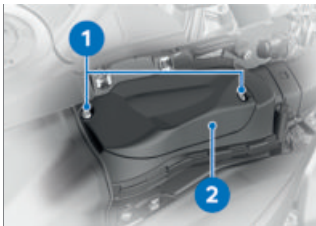

- Remove screws **1**.
- Remove air filter cover **2**.



- Remove frame **1** with air filter insert **2**.

Checking air-filter element

- Check the air filter element, clean as necessary.
» Replace the air-filter element if it is badly dirtied.

Installing air filter element



- Install frame **1** with air filter insert **2**.

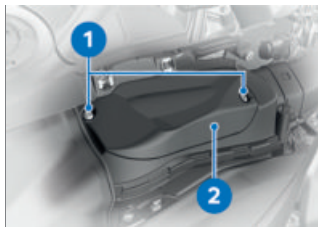

- Place air filter cover **2** in position.
- Install screws **1**.



Air filter cover to intake air silencer

3 Nm

- Install the right side panel. (→ 222)
- Install the rider's seat. (→ 135)

SIDE PANEL

Removing right side trim panel

 The procedure described here for the right side panel applies by analogy to the left side as well.

- Make sure the ground is level and firm and place the motorcycle on its stand.



- Slacken and remove threaded rivet **1**.

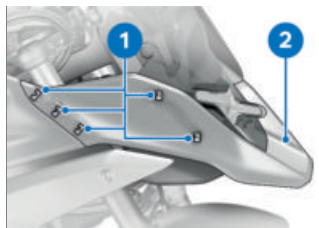

- Disengage front trim panel **2** from mounting clips **1** on left and right and remove.

222 MAINTENANCE

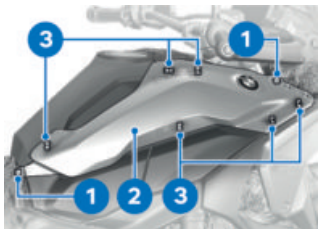

- Remove screws **1**.
- Disengage side trim panel **2** from mounting clips **3** and remove.

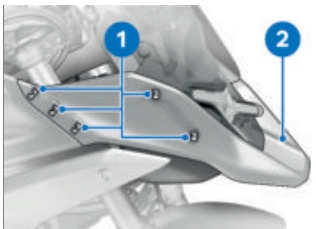

- Snap front trim panel **2** into mounting clips **1** on left and right.

Installing right side panel

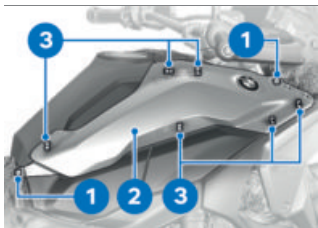

- Snap side trim panel **2** into mounting clips **3**.
- Install screws **1**.

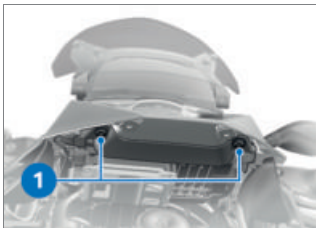

- Install threaded rivet **1**.

LIGHTING

Replacing LED light sources



WARNING

Vehicle overlooked in traffic due to failure of the lights on the vehicle

Safety risk

- Always replace a faulty bulb at the earliest possible opportunity. Consult a specialist workshop, preferably an authorised BMW Motorrad Retailer.

All light sources of the vehicle are LED light sources. The service life of the LED light sources is longer than the presumed vehicle service life. If an LED light source is faulty contact a specialist workshop, preferably an authorised BMW Motorrad retailer.

JUMP-STARTING



CAUTION

Touching live parts of the ignition system when the engine is running

Electric shock

- Do not touch parts of the ignition system when the engine is running.



ATTENTION

Excessive current flowing when the motorcycle is jump-started

Wiring smoulders/ignites or damage to the on-board electronics

- If the motorcycle has to be jump-started connect the leads to the battery terminals; never attempt to jump-start the engine by connecting leads to the on-board socket.

ATTENTION

Contact between crocodile clips of jump leads and vehicle

Risk of short-circuit

- Use jump leads fitted with fully insulated crocodile clips at both ends.

ATTENTION

Jump-starting with a voltage greater than 12 V

Damage to the on-board electronics

- Make sure that the battery of the donor vehicle has a voltage rating of 12 V.
- Make sure the ground is level and firm and place the motorcycle on its stand.
- Remove the rider's seat. (▶▶ 134)
- When jump-starting the engine, do not disconnect the battery from the on-board electrical system.

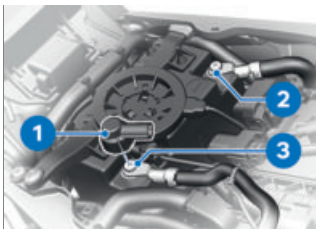

- Remove protective cap **1**.
- Use the red jumper cable to connect the positive terminal **3** of the discharged battery to the positive terminal of the donor battery.
- Connect one end of the black jump lead to the negative terminal of the donor battery, then connect the other end to negative terminal **2** of the discharged battery.

—with cold-climate version ^{OE}

- Use the red jumper cable to connect the positive terminal of the discharged battery to the positive terminal of the donor battery.
- Connect one end of the black jump lead to the negative terminal of the donor battery, then connect the other end to the negative terminal of the discharged battery.◀
- Run the engine of the donor vehicle during jump-starting.

- Start the engine of the vehicle with the discharged battery in the usual way; if the engine does not start, wait a few minutes before repeating the attempt in order to protect the starter motor and the donor battery.

 Do not use proprietary start-assist sprays or other products to start the engine.

- Allow both engines to idle for a few minutes before disconnecting the jump leads.
- Disconnect the jump lead from the negative terminals first, then disconnect the second lead from the positive terminals.

—without cold-climate version^{OE}

- Install protective cap 1.◀
- Install the rider's seat.
( 135)

BATTERY

Maintenance instructions

Correct upkeep, recharging and storage will prolong the life of the battery and are essential if warranty claims are to be considered.

Compliance with the points below is important in order to maximise battery life:

- Keep the surface of the battery clean and dry.
- Do not open the battery.
- Be sure to read and comply with the instructions for charging the battery on the following pages.
- Do not turn the battery upside down.



ATTENTION

On-board electronics (e.g. clock) draining connected battery

Battery is deep-discharged; this voids the guarantee

- Connect a float charger to the battery if the motorcycle is to remain out of use for more than four weeks.



BMW Motorrad has developed a float charger specially designed for compatibility with the electronics of your motorcycle. Using this charger, the battery can be kept charged during long periods of disuse, without having to be disconnected from the vehicle's on-board systems. For more information, consult an authorised BMW Motorrad retailer.

Recharging connected battery



ATTENTION

Charging the battery that is connected to the vehicle via the battery terminals

Damage to the on-board electronics

- Disconnect the battery at the battery terminals before charging.



ATTENTION

Recharging a fully discharged battery via the power socket or extra socket

Damage to the vehicle electronics

- If a battery has discharged to the extent that it is completely flat (battery voltage less than 12 V, indicator lights and multifunction display remain off when the ignition is switched on) always charge the **disconnected** battery with the charger connected directly to the battery terminals.



ATTENTION

Unsuitable chargers connected to a socket

Damage to charger and vehicle electronics

- Use suitable BMW chargers. The suitable charger is available from your authorised BMW Motorrad dealer.

- With the battery connected to the vehicle's on-board electrical system, charge via the power socket.



The motorcycle's on-board electronics know when the battery is fully charged. The on-board socket is switched off when this happens.

- Comply with the operating instructions of the charger.



If you are unable to charge the battery through the on-board socket, you may be using a charger that is not compatible with your motorcycle's electronics. If this happens, charge the battery directly at the terminals of the battery that is disconnected from the vehicle.

Recharging disconnected battery

- Charge the battery using a suitable charger.
- Comply with the operating instructions of the charger.
- Once the battery is fully charged, disconnect the charger's terminal clips from the battery terminals.

 The battery has to be recharged at regular intervals in the course of a lengthy period of disuse. See the instructions for caring for your battery. Always fully recharge the battery before restoring it to use.

Disconnecting battery from motorcycle



ATTENTION

Battery not disconnected in accordance with correct procedure

Risk of short-circuit

- Always proceed in compliance with the specified disconnection sequence.

- Make sure the ground is level and firm and place the motorcycle on its stand.
- Remove the rider's seat.
( 134)

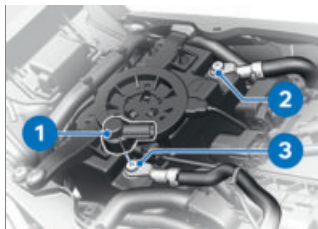

- Remove protective cap **1**.
- First disconnect negative battery cable **2**.
- Then disconnect positive battery cable **3**.

—with cold-climate version^{OE}

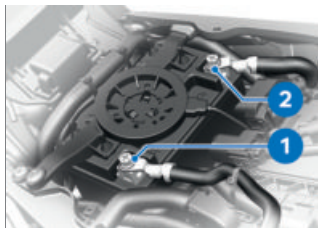

- First disconnect negative battery cable **2**.
- Then disconnect positive battery cable **1**.◁

228 MAINTENANCE

Connecting battery to motorcycle

ATTENTION

Battery not connected in accordance with correct procedure

Risk of short-circuit

- Always proceed in compliance with specified installation sequence.

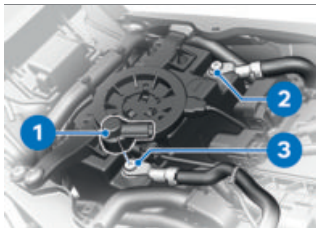

- First connect positive battery cable **3**.
- Then connect negative battery cable **2**.

 Wiring harness to battery

M6 x 8

4.5 Nm

–with cold-climate version^{OE}

M6 x 12

3.5 Nm◁

- Install protective cap **1**.

–with cold-climate version^{OE}

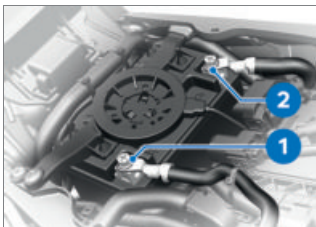

- First connect positive battery cable **1**.
- Then connect negative battery cable **2**.

 Wiring harness to battery

M6 x 8

4.5 Nm



M6 x 12

3.5 Nm◁

- Install the rider's seat.
( 135)

Removing battery

–with anti-theft alarm (DWA)^{OE}

- If applicable, switch off the anti-theft alarm.◁
- Switch off the ignition.
( 93)
- Disconnect the battery from the motorcycle. ( 227)

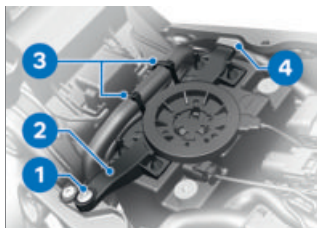

- Remove cable strap **3**.
- Remove screw **1**.
- Remove battery holder with ring aerial **2** from holder **4** and lay it on the tail of the vehicle, noting the cable of the ring aerial.

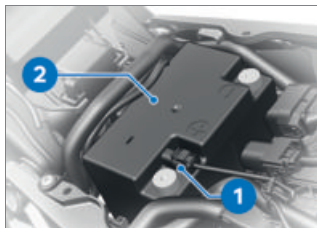

- Disconnect plug connection **1** from battery **2**.
- Lift battery **2** up and out; work it slightly back and forth if it is difficult to remove.

–with cold-climate version^{OE}

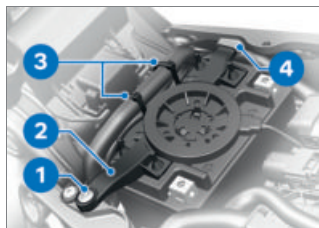

- Remove cable strap **3**.
- Remove screw **1**.
- Remove battery holder with ring aerial **2** from holder **4** and lay it on the tail of the vehicle, noting the cable of the ring aerial.

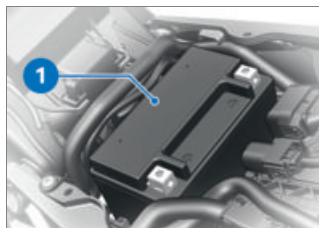

- Lift battery **1** up and out; work it slightly back and forth if it is difficult to remove.◁

Installing battery



If the vehicle has been disconnected from the battery for a significant time, the current date will have to be reset to guarantee correct operation of the service display.

230 MAINTENANCE

 After a change of battery type, the Fault in the on-board battery. Limited onward journey possible. Drive carefully to nearest specialist workshop. message is displayed once.

If you decide that you would like to change to a different battery type for your motorcycle, it is very important to consult a specialist workshop beforehand, preferably an authorised BMW Motorrad retailer.

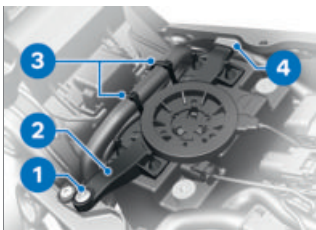

- Insert battery holder with ring aerial **2** into mount **4**, noting the cable of the ring aerial.
- Install screw **1**.
- Install cable strap **3**.

—with cold-climate version ^{OE}

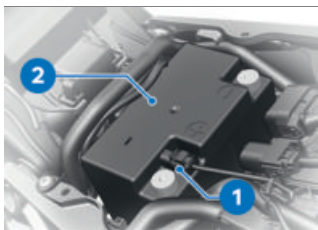

- Insert battery **2** into the battery compartment, positive terminal on the left in the forward direction of travel.
- Connect plug connection **1** to battery **2**.



- Insert battery **1** into the battery compartment, positive terminal on the left in the forward direction of travel.

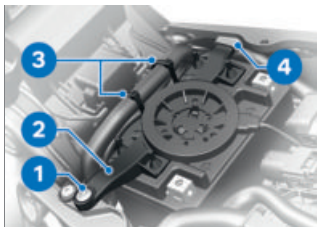

- Insert battery holder with ring aerial **2** into mount **4**, noting the cable of the ring aerial.
- Install screw **1**.
- Install cable strap **3**.◁
- Connect the battery to motorcycle. (▮▮▮ 228)
–with anti-theft alarm (DWA)^{OE}
- If applicable, switch on the anti-theft alarm.◁
- Change the system settings. (▮▮▮ 82)

FUSES

Replacing fuses

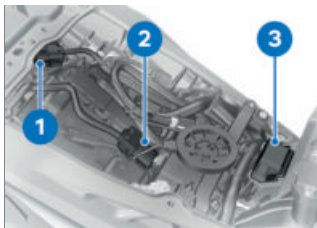

- Switch off the ignition.
- Remove the rider's seat. (▮▮▮ 134)

- Remove connector **1**, connector **2** or cap **3**.



ATTENTION

Jumpering of blown fuses

Risk of short-circuit and fire

- Never attempt to jumper a blown fuse.
 - Always replace a defective fuse with a new fuse of the same amperage.
- Replace faulty fuse in accordance with the fuse allocation diagram.



If fuse defects recur frequently have the electric circuits checked by a specialist workshop, preferably an authorised BMW Motorrad retailer.

- Insert connector **1**, connector **2** or cap **3**.
- Install the rider's seat. (▮▮▮ 135)

232 MAINTENANCE

Fuse assignment I

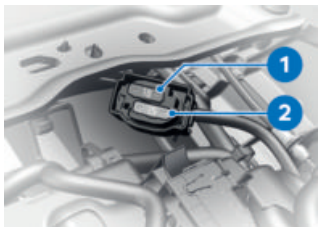

- 1** 10 A
Instrument cluster
Anti-theft alarm (DWA)
Socket for onboard diagnosis
Seat heating
Central locking, cases and topcase
- 2** 15 A
Keyless Ride
Coil, isolating relay
Headlight

Fuse assignment II

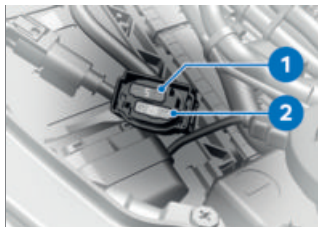

- 1** 5 A
Multifunction switch, left
Auxiliary headlights
CCP
- 2** 20 A
USB socket
Voltage supply, cases and topcase

Fuse assignment III

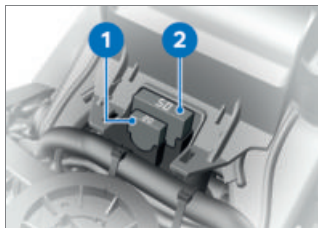

- 1** 20 A
Rear radar
Front radar
Sensor box
Windscreen motor
CCP

2 50 A Main fuse

DIAGNOSTIC CONNECTOR

Disengaging diagnostic socket



CAUTION

Incorrect disconnection of the diagnostic socket for on-board diagnosis

Malfunctions of the vehicle

- Do not disconnect the diagnostic socket or allow it to be disconnected except in the course of a BMW Motorrad service by a specialist workshop or by other authorised persons.
- Have the work carried out by appropriately trained personnel.
- Comply with the stipulations of the vehicle manufacturer.

- Remove the rider's seat. (▮▮▮▶ 134)

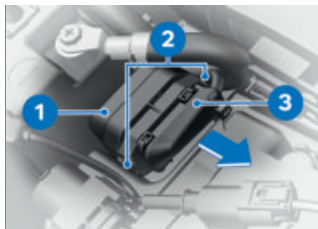

- Press locks **2**.
- Disengage diagnostic socket **3** from holder **1**.
 - » The interface to the diagnosis and information system can be connected to the diagnostic connector **3**.

Securing diagnostic socket

- Disconnect the interface for the diagnosis and information system.

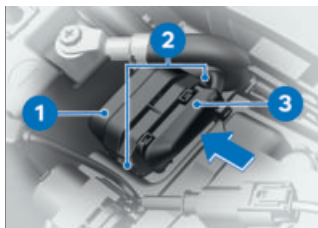

- Insert diagnostic socket **3** into holder **1**.
 - » Locks **2** engage on both sides.
- Install the rider's seat. (▮▮▮▶ 135)

ACCESSORIES

10

GENERAL NOTES	236
POWER SOCKETS	236
USB CHARGING SOCKETS	237
CASES	239
TOPCASE	244
NAVIGATION SYSTEM	249

GENERAL NOTES



CAUTION

Use of other-make products

Safety risk

- BMW Motorrad cannot examine or test each product of outside origin to ensure that it can be used on or in connection with BMW vehicles without constituting a safety hazard. Country-specific official authorisation does not suffice as assurance. Tests conducted by these instances cannot make provision for all operating conditions experienced by BMW vehicles and, consequently, they are not sufficient in some circumstances.
- Use only parts and accessories approved by BMW for your vehicle.

BMW has conducted extensive testing of the parts and accessory products to establish that they are safe, functional and suitable. Consequently, BMW accepts responsibility for the products. BMW accepts no liability whatsoever for parts and accessories that it has not approved.

All modifications must be in compliance with legal requirements. Make sure that the vehicle does not infringe the national road-vehicle construction and use regulations applicable in your country. Your authorised BMW Motorrad retailer can offer expert advice on the choice of genuine BMW parts, accessories and other products. To find out more about accessories go to:

bmw-motorrad.com/equipment

POWER SOCKETS

Connection of electrical devices

- You can start using electrical devices connected to the motorcycle's sockets only when the ignition is switched on.

Cable routing

- The cables from the power sockets to the auxiliary devices must be routed in such a way that they do not impede the rider.
- The cable routing should not restrict the steering angle or obstruct handling.
- The cables must not be trapped.

Automatic shutdown

- The sockets will be automatically switched off during the start procedure.
- The power supply to the sockets is switched off 60 seconds after the ignition is switched off, in order to prevent overloading of the on-board electrics. Low-wattage electrical accessories might not be recognised by the vehicle's electronics. In such cases, power sockets are switched off very shortly after the ignition is turned off.
- If the battery charge state is too low to maintain the motorcycle's start capability, the power sockets are switched off.
- The power sockets are also switched off when the maximum load capability as stated in the technical data is exceeded.

USB CHARGING SOCKETS

Notes on use



ATTENTION

Vibrations when vehicle is moving

Damage to mobile phones carried on the vehicle

- Make sure that the mobile phone carried on the vehicle is suitable for use on the motorcycle. Ask the manufacturer about related usage restrictions and comply with the information provided.

Automatic shutdown

The USB charging sockets are shut down automatically under the following circumstances:

- If battery charge state is too low, to maintain the vehicle's start capability.
- If the maximum load capacity as stated in the technical data is exceeded.
- During the starting operation.

Connection of electrical devices

You can start using electrical devices connected to the USB charging sockets only when the ignition is switched on. The power supply to the sockets is switched off no more than

238 ACCESSORIES

60 seconds after the ignition is switched off, in order to prevent overloading of the on-board electrics.

While riding in the rain, you should disconnect the device from the interface in order to protect against damage.

To prevent dirtying, keep the protective cover closed when no device is connected.

Cable routing

Note the following with regard to the routing of cables from USB charging sockets to items of electronic equipment:

- Make sure that cables do not impede the rider.
- Make sure that cables do not restrict the steering angle or obstruct handling.
- Make sure that cables cannot be trapped.

Storage compartment

The USB charging interface is underneath the storage compartment lid (▣▶ 132).



This is a 5 V USB charging interface **1** that provides a maximum charge current of 2.1 A (maximum charging power 10.5 W).

Cases

- with case^{OA}
- with central locking system^{OE}

The USB charging socket is inside the left case (▣▶ 239).



This is a 5 V USB charging interface **1** that provides a maximum charge current of 3 A (maximum charging power 15 W).

Topcase

- with topcase^{OA}
- with central locking system^{OE}

The USB charging socket is inside the topcase (► 244).



This is a 5 V USB charging interface **1** that provides a maximum charge current of 3 A (maximum charging power 15 W).

CASES

- with case^{OA}
- with central locking system^{OE}

Opening cases

- with central locking system^{OE}
- Unlock. (► 130)

Central locking system has failed or case has been locked and removed:

- with central locking system^{OE}
- with case^{OA}

or

- with central locking system^{OE}

–with topcase^{OA}

- Emergency unlocking. (► 131)

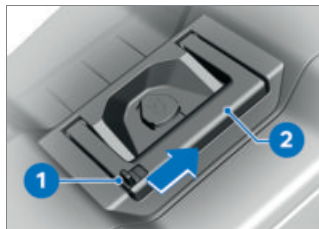

- Slide lock **1** to the right.
- » Carry handle **2** pops up.



- Press release button **1** and at the same time open the case lid.

Closing cases

- Close the case lid.
- » Make sure that the case lid engages with an audible click at both sides.

240 ACCESSORIES

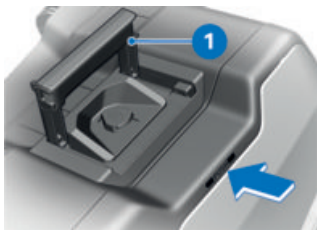

- Close carry handle **1**.
» Carry handle **1** engages with an audible click.
–with central locking system^{OE}
- Lock. (▣▣▣ 130)

Adjusting case volume

- with case^{OA}
- with central locking system^{OE}
- Open the case. (▣▣▣ 239)
- Empty the case.

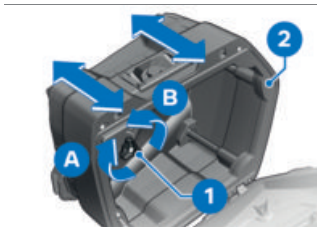

- To reduce case volume, turn adjustment wheel **1** clockwise in direction **A**.
» Adjustment frame **2** is pulled in.

- To increase case volume, turn adjustment wheel **1** counter-clockwise in direction **B**.
» Adjustment frame **2** is pushed out.
–with case^{OA}
- with central locking system^{OE}
- Close the case. (▣▣▣ 239)

Locking protective cap



- Turn the protective cap to position **1**.
» The protective cap engages with a perceptible snap.

Unlocking protective cap



- Turn the protective cap to position **1**.
» The protective cap engages with a perceptible snap.

Installing cases

- Unlock the protective cap.
( 240)

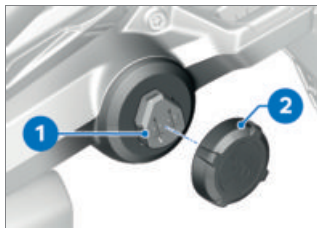

- Remove protective cap **2** from magnetic plug connection **1**.



- Turn the key to the **RELEASE** position in the case lock.
» The locking flap pops up.
- Turn the key in the case lock to position **1** and remove the key from the lock.

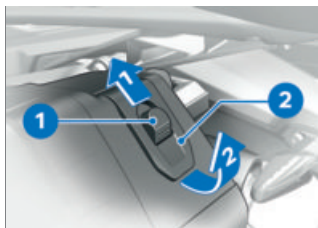

- Push release lever **1** up and fully open locking flap **2**.

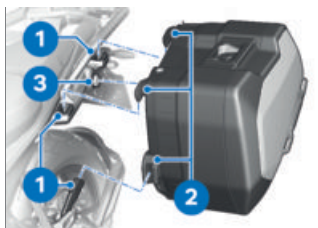

- Check magnetic plug connection **3** of case and case holder for dirt and damage.
- Engage hooks **2** securely in mounts **1**.

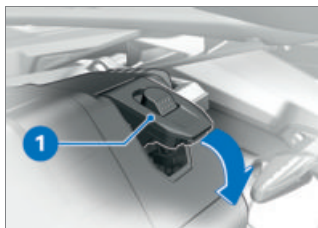

- Push locking flap **1** down until you feel some resistance.

242 ACCESSORIES

» The locking flap engages.



- Turn the key in the case lock to position **1** and remove the key from the lock.



- Install protective cap **3** on holder **2**.
 - with case^{OA}
 - with central locking system^{OE}
- Lock the protective cap.
(▮▮▮ 240)
- Close carry handle **1**.
 - » Carry handle **1** engages with an audible click.

Removing cases

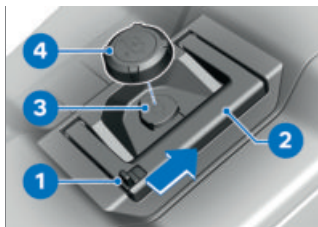

- Slide lock **1** to the right.
 - » Carry handle **2** pops up.
 - with case^{OA}
 - with central locking system^{OE}
- Unlock the protective cap.
(▮▮▮ 240)
- Remove protective cap **4** from holder **3**.



- Turn the key to the **RELEASE** position in the case lock.
 - » The locking flap pops up.
- Turn the key in the case lock to position **1** and remove the key from the lock.

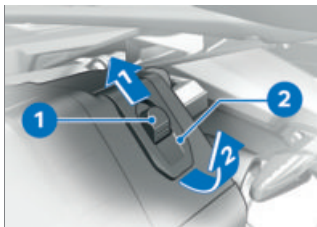

- Push release lever **1** up and fully open locking flap **2**.
- Take a firm grip of the carry handle and lift the case out of the case holder.
- Protect the magnetic plug connection of the case against damage, dirt and corrosion.
- Store cases where they will be clean and dry.

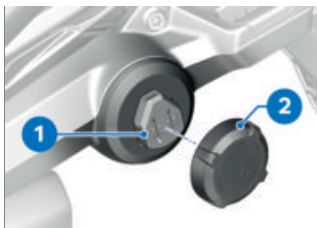

- Check protective cap **2** and magnetic plug connection **1** for dirt and damage.
- Install protective cap **2** on magnetic plug connection **1**.
- Lock the protective cap.
(▣▣▣▣▶ 240)

Maximum payload and maximum speed

 When lashing light items of luggage to the vehicle, take care not to put too much strain on the eyes (max 1 kg). Consequently, tighten straps or ropes by hand, without using any mechanical advantage (e.g. ratchet).

Note the maximum payload and the maximum permissible speed.

Always load cases in such a way that the motorcycle's stability against toppling over is sustained.

The values for the combination described here are as follows:



Maximum permissible speed for riding with Vario cases fitted to the motorcycle

max 180 km/h



Payload per Vario case

max 10 kg



Total weight with payload per Vario case

max 16.6 kg

244 ACCESSORIES

TOPCASE

- with topcase^{OA}
- with central locking system^{OE}

Opening topcase

- with central locking system^{OE}
- Unlock. (▣▣▣ 130)

Central locking system has failed or topcase has been locked and removed:

- with central locking system^{OE}
- with case^{OA}

or

- with central locking system^{OE}
- with topcase^{OA}

- Emergency unlocking. (▣▣▣ 131)



- Slide lock **1** to the right.
» Carry handle **2** pops up.



- Press release button **1** and open the topcase lid by the carry handle.

Closing topcase

- Press down firmly on the topcase lid to close.
» Make sure that the topcase lid engages with an audible click at both sides.

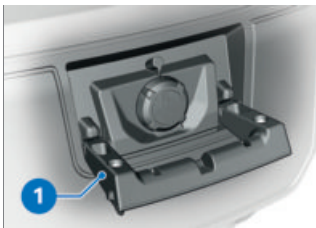

- Close carry handle **1**.
» Carry handle **1** engages with an audible click.
-with central locking system^{OE}
- Lock. (▣▣▣ 130)

Adjusting topcase volume

- with topcase^{OA}
- with central locking system^{OE}
- Open the topcase. (▶▶▶ 244)
- Empty the topcase.

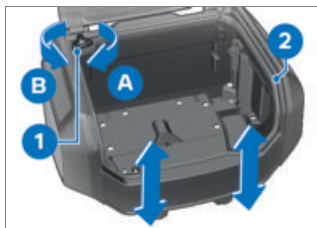

- Pull adjustment wheel **1** up to the adjustment position.
- To reduce volume, turn adjustment wheel **1** clockwise in direction **A**.
 - » Adjustment frame **2** is pulled in.
- To increase volume, turn adjustment wheel **1** counter-clockwise in direction **B**.
 - » Adjustment frame **2** is pushed out.
- Pull adjustment wheel **1** down to the initial position.
 - with topcase^{OA}
 - with central locking system^{OE}
- Close the topcase. (▶▶▶ 244)

Locking protective cap



- Turn the protective cap to position **1**.
 - » The protective cap engages with a perceptible snap.

Unlocking protective cap



- Turn the protective cap to position **1**.
 - » The protective cap engages with a perceptible snap.

246 ACCESSORIES

Installing topcase

WARNING

Luggage on topcase not secured in compliance with correct procedure

Impairment of handling stability

- Do not lash luggage carried on the topcase to the topcase carrier or to other movable parts.
- Before riding off, check that the topcase carrier has clearance on both sides.



- with topcase^{OA}
- with central locking system^{OE}

- Unlock the protective cap. (▣▣▣▣▶ 245)
- Remove protective cap **1** from magnetic plug connection **2**.



- Turn the key to the **RELEASE** position in the topcase lock.
» The locking flap pops up.
- Turn the key in the topcase lock to position **1** and remove the key from the lock.



- Fully open locking flap **1**.



- Check magnetic plug connection **2** of topcase and topcase holder for dirt and damage.
- Engage hooks **3** securely in mounts **1**.

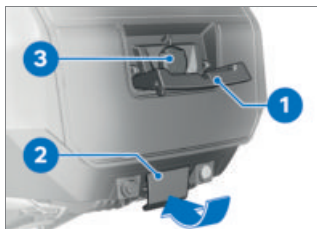

- Push locking flap **2** forward until resistance is perceptible.
 - » The locking flap engages.
- Install protective cap **3** on the holder.
- Close carry handle **1**.
 - » Carry handle **1** engages with an audible click.
- Lock the protective cap. (▮▮▮▮▶ 245)



- Turn the key in the topcase lock to position **1** and remove the key from the lock.

Removing topcase

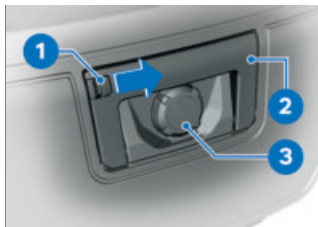

- Slide lock **1** to the right and pop carry handle **2** up.
- Unlock the protective cap. (▮▮▮▮▶ 245)
- Remove protective cap **3** from the holder.



- Turn the key to the **RELEASE** position in the topcase lock.
» The locking flap pops up.
- Turn the key in the topcase lock to position **1** and remove the key from the lock.



- Fully open locking flap **2**.
- Take a firm grip of carry handle **1** and lift the topcase out of the topcase holder.
- Protect the magnetic plug connection of the topcase against damage, dirt and corrosion.
- Store topcase where it will be clean and dry.



- Check protective cap **1** and magnetic plug connection **2** for dirt and damage.
- Install protective cap **1** on magnetic plug connection **2**.
–with topcase^{OA}
–with central locking system^{OE}
- Lock the protective cap.
(245)

Maximum payload and maximum speed

WARNING

Luggage on topcase not secured in compliance with correct procedure



Impairment of handling stability

- Do not lash luggage carried on the topcase to the topcase carrier or to other movable parts.
- Before riding off, check that the topcase carrier has clearance on both sides.

 When lashing light items of luggage to the vehicle, take care not to put too much strain on the eyes (max 2 kg). Tighten straps or ropes by hand, without using any mechanical advantage (e.g. ratchet).

Note the maximum payload and the maximum permissible speed.

The values for the combination described here are as follows:

	Maximum speed for riding with a laden Vario topcase
	max 180 km/h
	Payload of Vario topcase
	max 8 kg
	Total weight with payload of Vario topcase
	max 16.2 kg

NAVIGATION SYSTEM

–with preparation for navigation system^{OE}

Secure the navigation device

 Navigation preparation is suitable from BMW Motorrad Navigator IV onward.

 The latching system of the Mount Cradle is not designed to protect against theft. Always remove the navigation system and stow it away safely as soon as you finish your ride.

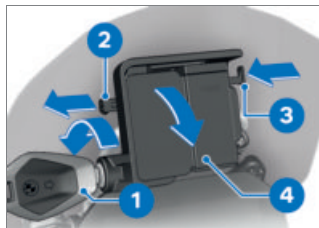

- Turn ignition key **1** counter-clockwise.
 - Pull the lock retainer **2** to the **left**.
 - Press the lock **3** in.
- » The Mount Cradle is unlocked and cover **4** can be pivoted forward and removed.

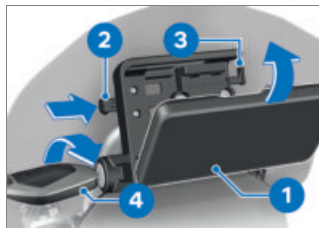

- Insert navigation device **1** at bottom and pivot it toward the rear.

250 ACCESSORIES

- » The navigation device engages with an audible click.
- Push the lock retainer **2** all the way to the **right**.
- » Lock **3** is locked.
- Turn ignition key **4** clockwise.
- » The navigation device is secured and the ignition key can be removed.

Remove the navigation device and install cover



ATTENTION

Dust and dirt on the Mount Cradle contacts

Damaged contacts

- Always reinstall the cover as soon as you finish your ride.

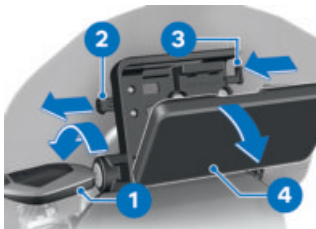

- Turn ignition key **1** anti-clockwise.
- Pull lock retainer **2** all the way to the **left**.
- » Lock **3** is unlocked.
- Push lock **3** all the way to the **left**.

- » The navigation device **4** is unlocked.
- Tilt the navigation device **4** down and remove.

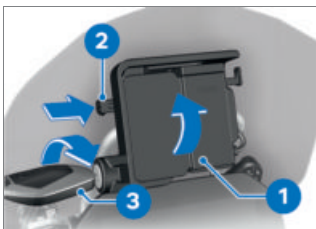

- Insert cover **1** in the lower section and swing to the top with a rotational movement.
- » The cover engages with an audible click.
- Push lock retainer **2** to the **right**.
- Turn ignition key **3** clockwise.
- » The cover **1** is secured.

Operating navigation system

 The description below is based on the BMW Motorrad ConnectedRide Navigator.

 Only the latest version of the BMW Motorrad communication system is supported. A software update of the BMW Motorrad communication system may be necessary. If this is the case, consult your

authorised BMW Motorrad retailer.

If the BMW Motorrad ConnectedRide Navigator is installed and the operating focus is switched to the Navigator (➔ 84), some of its functions can be operated without the rider removing a hand from the handlebars. If the BMW Motorrad ConnectedRide Navigator is connected, all the connections on the vehicle are automatically disconnected and re-established via the Navigator. The Navigation, Media and Telephone functions are now connected via the Navigator.



The navigation system is operated using Multi-Controller **1** and MENU rocker button **2**.

Turning Multi-Controller 1 up/down

- Select menu
- Change volume
- Zoom map

Short-tilting Multi-Controller 1 to left/right

- Confirm or cancel

Pressing bottom section of MENU rocker button 2

Switch operating focus to instrument cluster.

Special functions

The ConnectedRide Navigator has a n automatic operating focus changeover. For more details see the operating instructions of the ConnectedRide Navigator.

Security settings

Always follow the safety instructions in the operating instructions of the BMW Motorrad ConnectedRide Navigator.

CARE

11

CARE PRODUCTS	254
WASHING THE VEHICLE	254
CLEANING EASILY DAMAGED COMPONENTS	255
CARE OF PAINTWORK	256
PAINT PRESERVATION	257
LAYING UP MOTORCYCLE	257
RESTORING MOTORCYCLE TO USE	258

CARE PRODUCTS

ATTENTION

Use of unsuitable cleaning and care products

Damage to vehicle parts

- Do not use solvents such as cellulose thinners, cold cleaners, fuel or the like, and do not use cleaning products that contain alcohol.

ATTENTION

Use of strongly acidic or strongly alkaline cleaning agents

Damage to vehicle parts

- Dilute in accordance with the dilution ratio stated on the packaging of the cleaning agent.
- Do not use strongly acidic or strongly alkaline cleaning agents.

BMW Motorrad recommends that you use the cleaning and care products you can obtain from your authorised BMW Motorrad retailer. The substances in BMW Care Products have been tested in laboratories and in practice;

they provide optimised care and protection for the materials used in your vehicle.

WASHING THE VEHICLE

WARNING

Wet brake discs and brake pads after vehicle wash, after riding through water and in rainy conditions

Diminished braking effect, risk of accident

- Apply the brakes in good time to allow the friction and heat to dry the brake discs and brake pads.

ATTENTION

Damage due to high water pressure from high pressure cleaners or steam cleaners

Corrosion or short circuit, damage to labels, seals, hydraulic brake system, electrical system and the motorcycle seat

- Exercise restraint when using a steam jet or high pressure cleaning equipment.

BMW Motorrad recommends that you use BMW insect remover to soften and wash off insects and stubborn dirt on

painted parts prior to washing the vehicle.

To prevent stains, do not wash the vehicle immediately after it has been exposed to strong sunlight and do not wash it in the sun.

Remove dirt from the fork legs at regular intervals.

Make sure that the vehicle is washed frequently, especially during the winter months or if it is ridden on salted roads.



ATTENTION

Effect of road salt intensified by warm water

Corrosion

- Use only cold water to remove road salt deposits.

To remove road salt deposits, clean the vehicle and mounted parts, as applicable, with cold water immediately after every trip.



After a ride in the rain, when humidity is high or after the vehicle has been washed, condensation might form inside the headlight. This can cause temporary fogging on the headlight lens. If moisture is constantly present inside the headlight consult a specialist workshop, preferably an

authorised BMW Motorrad retailer.

CLEANING EASILY DAMAGED COMPONENTS

Plastics



ATTENTION

Use of unsuitable cleaning agents

Damage to plastic surfaces

- Do not use cleaning agents that contain alcohol, solvents or abrasives.
- Do not use insect-remover pads or cleaning pads with hard, scouring surfaces.

Clean the plastic parts with water and BMW plastic care product. This includes in particular:

- Windscreen and slipstream deflectors
- Headlight lens made of plastic
- Glass cover of the instrument cluster
- Black, unpainted parts



Soften stubborn dirt and insects by covering the affected areas with a wet cloth.

256 CARE

Instrument cluster

Clean the instrument cluster with warm water and washing-up liquid. Then dry it with a clean cloth, e.g. a paper towel.

Chrome

Carefully clean chrome parts with plenty of water and motorcycle cleaner from the BMW Care Products range. This is particularly important to counter the effects of salt. Use BMW Motorrad high-gloss polish for additional treatment.

Radiator

Clean the radiator regularly to prevent overheating of the engine due to inadequate cooling. For example, use a garden hose with low water pressure.

ATTENTION

Bending of radiator fins

Damage to radiator fins

- Take care not to bend the radiator fins when cleaning.

Rubber

ATTENTION

Application of silicone sprays to rubber seals

Damage to the rubber seals

- Do not use silicone sprays or care products that contain silicon.

Treat rubber components with water or BMW rubber-care products.

Radar sensors

–with Riding Assistant^{OE}

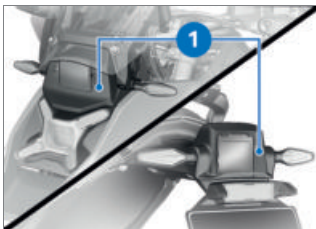

Clean covers **1** of the radar sensors with a cloth moistened with a proprietary glass cleaner.

CARE OF PAINTWORK

Washing the vehicle regularly will help counteract the long-term effects of substances that can damage the paint, especially if your vehicle is ridden in areas with high air pollution or

natural sources of dirt, for example tree resin or pollen. Remove particularly aggressive substances immediately, however, as otherwise the paint can be affected or become discoloured. Substances of this nature include spilt fuel, oil, grease, brake fluid and bird droppings. For this, we recommend BMW Motorrad solvent cleaner followed by BMW Motorrad gloss polish for preservation.

Marks on the paintwork are particularly easy to see after the motorcycle has been washed. Remove stains of this kind at the earliest possible opportunity, using benzine or petroleum spirit on a clean cloth or ball of cotton wool. BMW Motorrad recommends using BMW tar remover for removing specks of tar. Then apply preserving agent to the areas treated in this way.



ATTENTION

Damage to paintwork due to metal polish

Risk of damage

- Do not treat painted surfaces and chrome-painted surfaces with metal polish.

PAINT PRESERVATION

If water no longer rolls off the paint, the paint must be preserved.

For paint preservation, BMW Motorrad recommends the use of BMW Motorrad gloss polish or agents containing carnauba wax or synthetic wax.

 Do not use chrome polish to preserve chrome paints. Use only the agents recommended by BMW Motorrad.

LAYING UP MOTORCYCLE

- Fill the motorcycle's fuel tank.

 Fuel additives clean the fuel injection system and the combustion zone. It is advisable to use fuel additives when the engine is operated with low-grade fuel or if the vehicle is to be out of use for a lengthy period of time. More information is available from your authorised BMW Motorrad retailer.

- Clean the motorcycle.
- Remove the battery. (➡ 228) –with centre stand^{OE}
- Spray the hinged peg on the centre stand with a suitable lubricant.◁

258 CARE

- Spray the brake-lever and clutch-lever pivots mounts with suitable lubricant.

 The pivot mounts of the side stand and the centre stand are maintenance-free and require no lubrication.

- Coat bright metal and chrome-plated parts with an acid-free grease (e.g. Vaseline).
- Stand the motorcycle in a dry room in such a way that there is no load on either wheel.

RESTORING MOTORCYCLE TO USE

- Remove the protective wax coating.
- Clean the motorcycle.
- Install the battery.
- Note the checklist (➡ 151).

TECHNICAL DATA

12

TROUBLESHOOTING CHART	262
TREADED FASTENERS	264
FUEL	267
ENGINE OIL	268
ENGINE	268
CLUTCH	269
TRANSMISSION	269
FINAL DRIVE	269
FRAME	269
CHASSIS AND SUSPENSION	270
BRAKES	270
WHEELS AND TYRES	271
ELECTRICAL SYSTEM	272
ANTI-THEFT ALARM	273
DIMENSIONS	273
WEIGHTS	275
PERFORMANCE FIGURES	275

262 TECHNICAL DATA

TROUBLESHOOTING CHART

The engine does not start.

Possible cause	Rectification
Side stand extended and gear engaged	Retract the side stand.
Gear engaged and clutch not disengaged	Select neutral or pull the clutch lever.
No fuel in tank	Refuel. (►► 164)
Battery flat	Recharge the battery connected to the vehicle. (►► 226)
Starter motor overheating protection has tripped. The starter motor can be operated for a limited time only.	Allow the starter motor to cool down for approximately 1 minute before trying again.

The Bluetooth connection is not established.

Possible cause	Rectification
The steps required for pairing were not carried out.	Check the necessary steps for pairing in the operating instructions for the communication system.
The communication system was not connected automatically despite successful pairing.	Switch off the helmet's communication system and reconnect it after a minute or two.
Too many Bluetooth devices are saved on the helmet.	All pairing entries on the helmet are deleted (see the communication system operating instructions).
There are other vehicles with Bluetooth-capable devices in the vicinity.	Avoid simultaneously pairing with more vehicles.

Active route guidance is not displayed in the TFT display.

Possible cause	Rectification
Navigation from the BMW Motorrad Connected app was not transmitted.	Call up the BMW Motorrad Connected app on the paired mobile device prior to departure.
The route guidance cannot be started.	Make sure that the mobile device has a data connection and check the map data on the mobile device.

264 TECHNICAL DATA

THREADED FASTENERS

Front wheel	Value	Valid
Screw in quick-release axle		
M20 x 1.5	50 Nm	
Clamping screws for quick-release axle		
M6 x 30 - 10.9	Tightening sequence: Tighten screws six times in alternate sequence	
	12 Nm	
Radial brake caliper on telescopic forks		
M10 x 60	38 Nm	
Wheel-speed sensor to fork leg		
M6 x 16 Micro-encapsulated	8 Nm	
Rear wheel	Value	Valid
Rear wheel on wheel flange		
M10 x 1.25	Tightening sequence: tighten in diagonally opposite sequence	
	60 Nm	
Spray guard to bevel gears		
M6 x 20, Replace screws micro-encapsulated	8 Nm	

Mirrors	Value	Valid
Mirror (lock nut) to adapter		
M10 x 1.25	Left-hand thread, 22 Nm	
Mirror (bottom lock nut) to adapter		
M10 x 1.5	22 Nm	-with Riding Assistant ^{OE}

Gearshift lever	Value	Valid
Peg to gearshift lever		
M6 x 20 micro-encapsulated	10 Nm	





Footbrake lever	Value	Valid
Peg to footbrake lever		
M6 x 20 micro-encapsulated	10 Nm	

Footrests	Value	Valid
Clamping block on footrest hinge		
M8 x 25	20 Nm	
Footrest on clamping block		
M6 x 20 / M6 x 12	10 Nm	

266 TECHNICAL DATA

Handlebars	Value	Valid
Clamping block (handlebar clamp) on fork bridge		
M8 x 30	Tightening sequence: Tighten until seated at front as viewed in forward direction of travel 19 Nm	
One handlebar riser (15 mm), M8 x 45	Tightening sequence: Tighten until seated at front as viewed in forward direction of travel 19 Nm	–with handlebar extension ^{OE}
Two handlebar risers (30 mm), M8 x 60	Tightening sequence: Tighten until seated at front as viewed in forward direction of travel 19 Nm	
Battery	Value	Valid
Wiring harness to battery		
M6 x 8	4.5 Nm	
M6 x 12	3.5 Nm	–with cold-climate version ^{OE}

FUEL

Recommended fuel grade	 Premium unleaded (max 15 % ethanol, E10/E15)  95 ROZ/RON 90 AKI
Alternative fuel grade	 Normal unleaded (power- and consumption-related restrictions.) (max 15 % ethanol, E10/E15)  91 ROZ/RON 87 AKI
Usable fuel capacity	approx. 19 l
Reserve fuel	approx. 4 l
Fuel consumption	4.8 l/100 km, in accordance with WMTC
-with power reduction ^{OE}	4.9 l/100 km, in accordance with WMTC
CO2 emission	110 g/km, in accordance with WMTC
-with power reduction ^{OE}	113 g/km, in accordance with WMTC
Exhaust emissions standard	EU5

268 TECHNICAL DATA

ENGINE OIL

Engine oil, capacity	max 5.0 l, with filter change
Specification	SAE 5W-40, API SL / JASO MA2, Additives (e.g. molybdenum-based) are not permissible because they can attack coated components of the engine, BMW Motorrad recommends BMW Motorrad ADVANTEC Ultimate oil.
Engine oil, quantity for topping up	max 0.75 l, Difference between MIN and MAX

BMW recommends **ADVANTEC**
ORIGINAL BMW ENGINE OIL

ENGINE

Engine number location	Crankcase below left cylinder
Engine type	A75B13A
Engine design	Air-/liquid-cooled two-cylinder four-stroke boxer engine with two overhead camshafts, two balancing gearwheels and variable intake camshaft control BMW ShiftCam
Displacement	1300 cm ³
Compression ratio	13.3:1
Nominal capacity	107 kW, at rpm: 7750 min ⁻¹
-with power reduction ^{OE}	79 kW, at rpm: 6500 min ⁻¹
Torque	149 Nm, at rpm: 6500 min ⁻¹
-with power reduction ^{OE}	145 Nm, at rpm: 5000 min ⁻¹
Maximum engine speed	max 9000 min ⁻¹

Idle speed	1050 \pm 50 min ⁻¹ , Engine at regular operating temperature
------------	---

CLUTCH

Clutch type	Multi-plate oil-bath clutch, anti-hopping
-------------	---

TRANSMISSION

Type of transmission	Claw-shift 6-speed gearbox, integrated into engine block
----------------------	--

FINAL DRIVE

Gear ratio of final drive	2.909 (32/11 teeth)
Rear axle differential oil	SAE 70W-80

FRAME

Frame type	Frame monocoque sheet metal with partially load-bearing drive unit, rear frame die-cast aluminium
Type plate location	Frame, front right next to steering head
Position of the vehicle identification number	Frame, front right by steering head

270 TECHNICAL DATA

CHASSIS AND SUSPENSION

Front wheel

Type of front suspension	BMW Telelever
Design of front wheel suspension	Central shock absorber with helical spring
-with Dynamic Suspension Adjustment ^{OE}	Central shock absorber complete with torsion spring and header tank, spring-rate and ride-height adjustment, electrically adjustable rebound-stage and compression-stage damping
Spring travel, front	190 mm, at front wheel
-with sport suspension ^{OE}	210 mm, at front wheel

Rear wheel

Type of rear suspension	Cast aluminium single swinging arm with BMW Motorrad Paralever
Spring travel at rear wheel	200 mm, at rear wheel
-with sport suspension ^{OE}	220 mm, at rear wheel

BRAKES

Front wheel

Type of front brake	Twin disc brakes, floating brake discs, diameter 310 mm, 4-piston radial calipers
Brake-pad material, front	Sintered metal
Brake disc thickness, front	4.5 mm, When new min 4.0 mm, Wear limit
Free travel of brake controls (Front wheel brake lever)	1.6...2.1 mm, at the piston

Rear wheel

Type of rear brake	Single-disc brake, diameter 285 mm, 2-piston floating caliper
Brake-pad material, rear	Sintered metal
Brake disc thickness, rear	5.0 mm, When new min 4.5 mm, Wear limit
Blow-by clearance of the foot-brake lever	1...1.5 mm, between the frame and the footbrake lever

WHEELS AND TYRES

Speed category, front/rear tyres	V, required at least: 240 km/h
----------------------------------	--------------------------------

Front wheel

Front-wheel type	Aluminium cast wheel
-with cross-spoked wheels ^{OE} or -with cross-spoked wheels ^{OE}	Cross-spoked wheel
-with enduro forged wheel ^{OE}	Forged aluminium wheels
Front-wheel rim size	3.00" x 19"
Tyre designation, front	120/70 R 19
Load index, front tyre	min. 60
Permissible front-wheel imbalance	max 5 g

272 TECHNICAL DATA

Rear wheel	
Rear-wheel type	Aluminium cast wheel
-with cross-spoked wheels ^{OE} or -with cross-spoked wheels ^{OE}	Cross-spoked wheel
-with enduro forged wheel ^{OE}	Forged aluminium wheels
Rear wheel rim size	4.50" x 17"
Tyre designation, rear	170/60 R 17
Load index, rear tyre	min. 72
Permissible rear-wheel imbalance	max 5 g
Tyre pressures	
Tyre pressure, front	2.5 bar, tyre cold
Tyre pressure, rear	2.9 bar, tyre cold

ELECTRICAL SYSTEM

Electrical rating of on-board sockets	max 12 A, Total for all sockets
Main fuse	50 A, Main fuse
Fuse 1	10 A, Instrument cluster, anti-theft alarm system (DWA), OBD socket, seat heating, central locking system for cases and topcase
Fuse 2	15 A, Cut-off relay, Key-less Ride, headlight
Fuse 3	20 A, Rear radar, front radar, CCP, windscreen motor, sensor box
Fuse 4	20 A, USB socket, voltage supply to cases and topcase

Fuse 5	5 A, CCP 30G, auxiliary headlights, left multifunction switch
--------	---

Battery

Battery type	Lithium-ion battery, maintenance-free
-with cold-climate version ^{OE}	AGM battery (Absorbent Glass Mat), maintenance-free
Battery rated voltage	12 V
Battery rated capacity	10 Ah
-with Option 719 Billet Pack Shadow ^{OE}	14 Ah

Spark plugs

Spark plugs, manufacturer and designation	NGK LMAR8AI-10
---	----------------

Lighting

All light sources	LED
-------------------	-----

ANTI-THEFT ALARM

Battery type (For Keyless Ride radio-operated key)	CR 2032
--	---------

DIMENSIONS

Length of motorcycle	2212 mm, over spray guard
-with topcase holder ^{OE}	2268 mm, Across luggage carrier

274 TECHNICAL DATA

Height of motorcycle	1406 mm, without mirrors, over windscreen, at DIN unladen weight
-with Adaptive Ride Height ^{OE}	1376 mm, without mirrors, over windscreen, at DIN unladen weight
-with windscreen, electrically adjustable ^{OE} -with Adaptive Ride Height ^{OE}	1459 mm, without mirrors, over windscreen, at DIN unladen weight
-with sport suspension ^{OE}	1426 mm, without mirrors, over windscreen, at DIN unladen weight
-with windscreen, electrically adjustable ^{OE}	1489 mm, without mirrors, over windscreen, at DIN unladen weight
-with sport suspension ^{OE} -with windscreen, electrically adjustable ^{OE}	1509 mm, without mirrors, over windscreen, at DIN unladen weight
Width of motorcycle	1000 mm, with hand protectors
Height of rider's seat	850...870 mm, without rider, at DIN unladen weight
-with two-up riding package ^{OE} -with sport suspension ^{OE}	870...890 mm, without rider, at DIN unladen weight
Rider's inside-leg arc, heel to heel	1870...1910 mm, without rider, at DIN unladen weight
-with two-up riding package ^{OE} -with sport suspension ^{OE}	1910...1950 mm, without rider, at DIN unladen weight
-with seat heating ^{OE}	1920...1940 mm, without rider, at DIN unladen weight

WEIGHTS

Vehicle kerb weight	237 kg, DIN unladen weight, ready for road 90 % load of fuel, without OE
Permissible gross vehicle weight	465 kg
Maximum payload	227.6 kg

PERFORMANCE FIGURES

Top speed	225 km/h
-with power reduction ^{OE}	204 km/h
-with case ^{OA} or -with topcase ^{OA} or -with tank bag ^{OA}	180 km/h

SERVICE

13

REPORTING SAFETY-RELEVANT DEFECTS	278
RECYCLING	279
BMW MOTORRAD SERVICE	279
BMW MOTORRAD SERVICE HISTORY	280
BMW MOTORRAD MOBILITY SERVICES	280
MAINTENANCE WORK	280
MAINTENANCE SCHEDULE	282
BMW MOTORRAD RUNNING-IN CHECK	283
MAINTENANCE CONFIRMATIONS	284
SERVICE CONFIRMATIONS	296

REPORTING SAFETY-RELEVANT DEFECTS

—with Canada export^{NV}

If you believe that your vehicle has a defect which could cause a crash or could cause injury or death, you should immediately inform the NHTSA (National Highway Traffic Safety Administration) in addition to notifying the BMW of North America, LLC.

If the NHTSA receives other, similar complaints, it may open an investigation. If it finds that a safety defect exists in a group of vehicles, the NHTSA it may order a recall and remedy campaign. However, the NHTSA cannot become involved in individual problems between you, your retailer, or BMW of North America, LLC. You can contact the NHTSA by calling the Vehicle Safety Hotline on 1-888-327-4236 (teletypewriter TTY for the hearing impaired: 1-800-424-9153) toll-free, by visiting the website at <http://www.safercar.gov> or by writing to Administrator, NHTSA, 400 Seventh Street, SW., Washington, DC 20590. Further information on vehicle safety is available at <http://www.safercar.gov>.

Canadian customers who wish to report a safety-related defect to Transport Canada, Defect Investigations and Recalls can call the toll-free hotline 1-800-333-0510. You can obtain further information about motor vehicle safety from <http://www.tc.gc.ca/roadsafety>.

RECYCLING

–with France export^{NV}

Disposal of the rider's manual

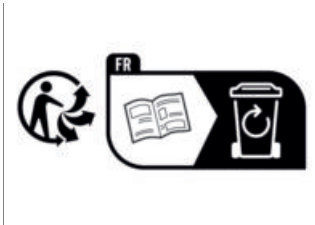

Dispose of this rider's manual by depositing it in the container provided for the purpose.

BMW MOTORRAD SERVICE

BMW Motorrad has an extensive network of retailers in place to look after you and your motorcycle in more than 100 countries. Authorised BMW Motorrad retailers have the technical information and the technical know-how to carry out reliably all preventive maintenance and repair work on your BMW.

You can locate the nearest authorised BMW Motorrad retailer by visiting our website: bmw-motorrad.com.

WARNING

Maintenance and repair work not in compliance with correct procedure

Risk of accident due to consequential damage

- BMW Motorrad recommends having work of this nature carried out on the vehicle by a specialist workshop, preferably an authorised BMW Motorrad dealer.

In order to help ensure that your BMW is always in optimum condition, BMW Motorrad recommends compliance with the maintenance intervals specified for your motorcycle.

Have all maintenance and repair work carried out confirmed in the "Service" chapter in this manual. Evidence of regular preventive maintenance is essential for generous treatment of claims submitted after the warranty period has expired.

280 SERVICE

You can inquire about the content of BMW Motorrad services at your authorised BMW Motorrad retailer.

BMW MOTORRAD SERVICE HISTORY

Entries

Maintenance work that has been carried out is entered in the proof of maintenance. The entries are like a Service Booklet and provide proof of regular maintenance.

When an entry is made in the electronic service booklet of the vehicle, service-relevant data is saved in the central IT systems accessible through BMW.

If there is a change in vehicle ownership, the data saved in the electronic service booklet can also be viewed by the new vehicle owner. An authorised BMW Motorrad retailer or a specialist workshop can also view data that is stored in the electronic service booklet.

Objection

The vehicle owner can object to entries being made by the authorised BMW Motorrad retailer or a specialist workshop in the electronic service

booklet along with the corresponding storage of data in the vehicle and transfer of data to the vehicle manufacturer for the period of time that they are the vehicle owner. In this instance, no entry is made in the electronic service booklet of the vehicle.

BMW MOTORRAD MOBILITY SERVICES

As owner of a new BMW vehicle, in circumstances in which assistance is required you can benefit from the protection afforded by the various BMW Motorrad mobility services (e.g. Mobile Service, breakdown service, vehicle recovery service).

Ask your authorised BMW Motorrad retailer for information about the mobility services offered.

MAINTENANCE WORK

BMW pre-delivery check

The BMW pre-delivery check is performed by your authorised BMW Motorrad retailer before the vehicle is handed over to you.

BMW Running-in Check

The BMW running-in check has to be performed when the motorcycle has covered between 500 km and 1200 km.

BMW Motorrad Service

The BMW Motorrad Service is carried out once a year; the extent of servicing can vary, depending on the age of the vehicle and the distance it has covered. Your authorised BMW Motorrad retailer confirms that the service work has been carried out and enters the date when the next service will be due.

Riders who cover long distances in a year might have to bring in their vehicles for service before the next scheduled date. It is to allow for these cases that a maximum odometer reading is entered as well in the confirmation of service. Servicing has to be brought forward if this odometer reading is reached before the next scheduled date for the service.

The service-due indicator in the display reminds you about one month or 1000 km in advance when the time for a service is approaching.

To find out more about service go to:

bmw-motorrad.com/service

The maintenance tasks necessary for your vehicle are set out in the maintenance schedule below. The tasks listed are due either when the vehicle has covered the stated distances, or periodically at the stated times.

282 SERVICE

MAINTENANCE SCHEDULE

	500 -1200 km 300 - 750 mls	10 000 km 6 000 mls	20 000 km 12 000 mls	30 000 km 18 000 mls	40 000 km 24 000 mls	50 000 km 30 000 mls	60 000 km 36 000 mls	70 000 km 42 000 mls	80 000 km 48 000 mls	90 000 km 54 000 mls	100 000 km 60 000 mls	12 months	24 months
1	X												
2		X	X	X	X	X	X	X	X	X	X	X ^a	
3		X	X	X	X	X	X	X	X	X	X	X ^a	
4			X		X		X		X		X		X ^b
5			X		X		X		X		X		
6			X		X		X		X		X		
7			X		X		X		X		X		
8			X		X		X		X		X		
9									X ^d				
10												X ^c	X ^c

- 1 BMW running-in check (including oil change and oil filter change)
- 2 BMW Motorrad Service, standard scope
- 3 Engine-oil change, with filter
- 4 Oil change in bevel gears rear
- 5 Check valve clearances
- 6 Replace all spark plugs
- 7 Replace air-filter element
- 8 Cardan shaft, visual inspection and lubrication
- 9 Replace Cardan shaft

- 10 Change brake fluid, entire system
 - a annually or every 10000 km (whichever comes first)
 - b every two years or every 20000 km (whichever comes first)
 - c for the first time after one year, then every two years
 - d referenced to the distance over which the component was in use

BMW MOTORRAD RUNNING-IN CHECK

BMW Motorrad running-in check

The tasks included in the BMW Motorrad running-in check are listed below. The actual scope of work applicable for your vehicle may vary.

- Setting service-due data and countdown distance
- Performing vehicle test with BMW Motorrad diagnostic system
- Engine-oil change, with filter
- Changing oil in bevel gears
- Check the brake-fluid level, front wheel brake
- Check the brake-fluid level, rear wheel brake
- Check the coolant level
- Checking tyre tread depth and tyre pressures
- Checking lighting and signalling system
- Check the tension of the spokes, adjust if necessary
- Function test, engine start suppression
- Final inspection and check of roadworthiness
- Performing vehicle test with BMW Motorrad diagnostic system
- Confirm the BMW service in the on-board literature

MAINTENANCE CONFIRMATIONS

BMW Motorrad Service standard scope

The tasks included in the BMW Motorrad Service standard scope are listed below. The actual scope of maintenance work applicable for your vehicle may vary.

- Performing vehicle test with BMW Motorrad diagnostic system
- Visual inspection of clutch system
- Visual inspection of the brake lines, brake hoses and connections
- Check the front brake pads and brake discs for wear
- Check the brake-fluid level, front wheel brake
- Check the rear brake pads and brake disc for wear
- Check the brake-fluid level, rear wheel brake
- Check the coolant level
- Checking flexor panel on handlebar bridge
- Check the side stand's ease of movement
- Check the ease of movement of the centre stand
- Check the tyre pressures and tread depth
- Check the tension of the spokes, adjust if necessary
- Checking lighting and signalling system
- Function test, engine start suppression
- Final inspection and check of roadworthiness
- Performing vehicle test with BMW Motorrad diagnostic system
- Setting service-due date and countdown distance with BMW Motorrad diagnostic system
- Checking battery state of charge
- Confirm the BMW Motorrad service in the on-board literature

BMW Motorrad pre-delivery check

carried out

on _____

Stamp, signature

BMW Motorrad running-in check

carried out

on _____

odometer reading _____

Next service

at the latest

on _____

or, when reached earlier

odometer reading _____

Stamp, signature

BMW Motorrad service

carried out

on _____

odometer reading _____

Next service

at the latest

on _____

or, when reached earlier

odometer reading _____

Work performed

	Yes	No
BMW Motorrad service	<input type="checkbox"/>	<input type="checkbox"/>
Engine oil change with filter	<input type="checkbox"/>	<input type="checkbox"/>
Oil change in rear angular gearbox	<input type="checkbox"/>	<input type="checkbox"/>
Checking valve clearance	<input type="checkbox"/>	<input type="checkbox"/>
Renewing all spark plugs	<input type="checkbox"/>	<input type="checkbox"/>
Replacing the air filter element	<input type="checkbox"/>	<input type="checkbox"/>
Visual inspection and lubricate Cardan shaft (during service)	<input type="checkbox"/>	<input type="checkbox"/>
Checking Cardan shaft	<input type="checkbox"/>	<input type="checkbox"/>
Removing/installing or replacing the Cardan shaft	<input type="checkbox"/>	<input type="checkbox"/>
Changing the brake fluid in the entire sys- tem	<input type="checkbox"/>	<input type="checkbox"/>

Notes

Stamp, signature

BMW Motorrad service

carried out

on _____

odometer reading _____

Next service

at the latest

on _____

or, when reached earlier

odometer reading _____

Work performed

	Yes	No
BMW Motorrad service	<input type="checkbox"/>	<input type="checkbox"/>
Engine oil change with filter	<input type="checkbox"/>	<input type="checkbox"/>
Oil change in rear angular gearbox	<input type="checkbox"/>	<input type="checkbox"/>
Checking valve clearance	<input type="checkbox"/>	<input type="checkbox"/>
Renewing all spark plugs	<input type="checkbox"/>	<input type="checkbox"/>
Replacing the air filter element	<input type="checkbox"/>	<input type="checkbox"/>
Visual inspection and lubricate Cardan shaft (during service)	<input type="checkbox"/>	<input type="checkbox"/>
Checking Cardan shaft	<input type="checkbox"/>	<input type="checkbox"/>
Removing/installing or replacing the Cardan shaft	<input type="checkbox"/>	<input type="checkbox"/>
Changing the brake fluid in the entire sys- tem	<input type="checkbox"/>	<input type="checkbox"/>

Notes

Stamp, signature

BMW Motorrad service

carried out

on _____

odometer reading _____

Next service

at the latest

on _____

or, when reached earlier

odometer reading _____

Work performed

	Yes	No
BMW Motorrad service	<input type="checkbox"/>	<input type="checkbox"/>
Engine oil change with filter	<input type="checkbox"/>	<input type="checkbox"/>
Oil change in rear angular gearbox	<input type="checkbox"/>	<input type="checkbox"/>
Checking valve clearance	<input type="checkbox"/>	<input type="checkbox"/>
Renewing all spark plugs	<input type="checkbox"/>	<input type="checkbox"/>
Replacing the air filter element	<input type="checkbox"/>	<input type="checkbox"/>
Visual inspection and lubricate Cardan shaft (during service)	<input type="checkbox"/>	<input type="checkbox"/>
Checking Cardan shaft	<input type="checkbox"/>	<input type="checkbox"/>
Removing/installing or replacing the Cardan shaft	<input type="checkbox"/>	<input type="checkbox"/>
Changing the brake fluid in the entire sys- tem	<input type="checkbox"/>	<input type="checkbox"/>

Notes

Stamp, signature

BMW Motorrad service

carried out

on _____

odometer reading _____

Next service

at the latest

on _____

or, when reached earlier

odometer reading _____

Work performed

	Yes	No
BMW Motorrad service	<input type="checkbox"/>	<input type="checkbox"/>
Engine oil change with filter	<input type="checkbox"/>	<input type="checkbox"/>
Oil change in rear angular gearbox	<input type="checkbox"/>	<input type="checkbox"/>
Checking valve clearance	<input type="checkbox"/>	<input type="checkbox"/>
Renewing all spark plugs	<input type="checkbox"/>	<input type="checkbox"/>
Replacing the air filter element	<input type="checkbox"/>	<input type="checkbox"/>
Visual inspection and lubricate Cardan shaft (during service)	<input type="checkbox"/>	<input type="checkbox"/>
Checking Cardan shaft	<input type="checkbox"/>	<input type="checkbox"/>
Removing/installing or replacing the Cardan shaft	<input type="checkbox"/>	<input type="checkbox"/>
Changing the brake fluid in the entire sys- tem	<input type="checkbox"/>	<input type="checkbox"/>

Notes

Stamp, signature

290 SERVICE

BMW Motorrad service

carried out

on _____

odometer reading _____

Next service

at the latest

on _____

or, when reached earlier

odometer reading _____

Work performed

	Yes	No
BMW Motorrad service	<input type="checkbox"/>	<input type="checkbox"/>
Engine oil change with filter	<input type="checkbox"/>	<input type="checkbox"/>
Oil change in rear angular gearbox	<input type="checkbox"/>	<input type="checkbox"/>
Checking valve clearance	<input type="checkbox"/>	<input type="checkbox"/>
Renewing all spark plugs	<input type="checkbox"/>	<input type="checkbox"/>
Replacing the air filter element	<input type="checkbox"/>	<input type="checkbox"/>
Visual inspection and lubricate Cardan shaft (during service)	<input type="checkbox"/>	<input type="checkbox"/>
Checking Cardan shaft	<input type="checkbox"/>	<input type="checkbox"/>
Removing/installing or replacing the Cardan shaft	<input type="checkbox"/>	<input type="checkbox"/>
Changing the brake fluid in the entire sys- tem	<input type="checkbox"/>	<input type="checkbox"/>

Notes

Stamp, signature

BMW Motorrad service

carried out

on _____

odometer reading _____

Next service

at the latest

on _____

or, when reached earlier

odometer reading _____

Work performed

	Yes	No
BMW Motorrad service	<input type="checkbox"/>	<input type="checkbox"/>
Engine oil change with filter	<input type="checkbox"/>	<input type="checkbox"/>
Oil change in rear angular gearbox	<input type="checkbox"/>	<input type="checkbox"/>
Checking valve clearance	<input type="checkbox"/>	<input type="checkbox"/>
Renewing all spark plugs	<input type="checkbox"/>	<input type="checkbox"/>
Replacing the air filter element	<input type="checkbox"/>	<input type="checkbox"/>
Visual inspection and lubricate Cardan shaft (during service)	<input type="checkbox"/>	<input type="checkbox"/>
Checking Cardan shaft	<input type="checkbox"/>	<input type="checkbox"/>
Removing/installing or replacing the Cardan shaft	<input type="checkbox"/>	<input type="checkbox"/>
Changing the brake fluid in the entire sys- tem	<input type="checkbox"/>	<input type="checkbox"/>

Notes

Stamp, signature

292 SERVICE

BMW Motorrad service

carried out

on _____

odometer reading _____

Next service

at the latest

on _____

or, when reached earlier

odometer reading _____

Work performed

	Yes	No
BMW Motorrad service	<input type="checkbox"/>	<input type="checkbox"/>
Engine oil change with filter	<input type="checkbox"/>	<input type="checkbox"/>
Oil change in rear angular gearbox	<input type="checkbox"/>	<input type="checkbox"/>
Checking valve clearance	<input type="checkbox"/>	<input type="checkbox"/>
Renewing all spark plugs	<input type="checkbox"/>	<input type="checkbox"/>
Replacing the air filter element	<input type="checkbox"/>	<input type="checkbox"/>
Visual inspection and lubricate Cardan shaft (during service)	<input type="checkbox"/>	<input type="checkbox"/>
Checking Cardan shaft	<input type="checkbox"/>	<input type="checkbox"/>
Removing/installing or replacing the Cardan shaft	<input type="checkbox"/>	<input type="checkbox"/>
Changing the brake fluid in the entire sys- tem	<input type="checkbox"/>	<input type="checkbox"/>

Notes

Stamp, signature

BMW Motorrad service

carried out

on _____

odometer reading _____

Next service

at the latest

on _____

or, when reached earlier

odometer reading _____

Work performed

	Yes	No
BMW Motorrad service	<input type="checkbox"/>	<input type="checkbox"/>
Engine oil change with filter	<input type="checkbox"/>	<input type="checkbox"/>
Oil change in rear angular gearbox	<input type="checkbox"/>	<input type="checkbox"/>
Checking valve clearance	<input type="checkbox"/>	<input type="checkbox"/>
Renewing all spark plugs	<input type="checkbox"/>	<input type="checkbox"/>
Replacing the air filter element	<input type="checkbox"/>	<input type="checkbox"/>
Visual inspection and lubricate Cardan shaft (during service)	<input type="checkbox"/>	<input type="checkbox"/>
Checking Cardan shaft	<input type="checkbox"/>	<input type="checkbox"/>
Removing/installing or replacing the Cardan shaft	<input type="checkbox"/>	<input type="checkbox"/>
Changing the brake fluid in the entire sys- tem	<input type="checkbox"/>	<input type="checkbox"/>

Notes

Stamp, signature

294 SERVICE

BMW Motorrad service

carried out

on _____

odometer reading _____

Next service

at the latest

on _____

or, when reached earlier

odometer reading _____

Work performed

	Yes	No
BMW Motorrad service	<input type="checkbox"/>	<input type="checkbox"/>
Engine oil change with filter	<input type="checkbox"/>	<input type="checkbox"/>
Oil change in rear angular gearbox	<input type="checkbox"/>	<input type="checkbox"/>
Checking valve clearance	<input type="checkbox"/>	<input type="checkbox"/>
Renewing all spark plugs	<input type="checkbox"/>	<input type="checkbox"/>
Replacing the air filter element	<input type="checkbox"/>	<input type="checkbox"/>
Visual inspection and lubricate Cardan shaft (during service)	<input type="checkbox"/>	<input type="checkbox"/>
Checking Cardan shaft	<input type="checkbox"/>	<input type="checkbox"/>
Removing/installing or replacing the Cardan shaft	<input type="checkbox"/>	<input type="checkbox"/>
Changing the brake fluid in the entire sys- tem	<input type="checkbox"/>	<input type="checkbox"/>

Notes

Stamp, signature

BMW Motorrad service

carried out

on _____

odometer reading _____

Next service

at the latest

on _____

or, when reached earlier

odometer reading _____

Work performed

	Yes	No
BMW Motorrad service	<input type="checkbox"/>	<input type="checkbox"/>
Engine oil change with filter	<input type="checkbox"/>	<input type="checkbox"/>
Oil change in rear angular gearbox	<input type="checkbox"/>	<input type="checkbox"/>
Checking valve clearance	<input type="checkbox"/>	<input type="checkbox"/>
Renewing all spark plugs	<input type="checkbox"/>	<input type="checkbox"/>
Replacing the air filter element	<input type="checkbox"/>	<input type="checkbox"/>
Visual inspection and lubricate Cardan shaft (during service)	<input type="checkbox"/>	<input type="checkbox"/>
Checking Cardan shaft	<input type="checkbox"/>	<input type="checkbox"/>
Removing/installing or replacing the Cardan shaft	<input type="checkbox"/>	<input type="checkbox"/>
Changing the brake fluid in the entire sys- tem	<input type="checkbox"/>	<input type="checkbox"/>

Notes

Stamp, signature

DECLARATION OF CONFORMITY	299
RADIO EQUIPMENT TFT INSTRUMENT CLUSTER	303
KEYLESS RIDE SYSTEM MAIN UNIT	304
KEYLESS RIDE SYSTEM ACTIVE KEY	307
MID RANGE RADAR	311
SHORT RANGE RADAR	314
RADIO EQUIPMENT TYRE PRESSURE CONTROL (RDC)	316
RADIO EQUIPMENT INTELLIGENT EMERGENCY CALL	317

DECLARATION OF CONFORMITY**Manufacturer**

Bayerische Motoren Werke Aktiengesellschaft
 Petuelring 130, 80809 Munich, Germany

**Simplified EU Declaration of Conformity according to EU RED
 (2014/53/EU).**



**Simplified UK Declaration of Conformity according to Radio
 Equipment Regulations 2017 of the United Kingdom.**



Hereby, BMW AG declares that the radio equipment components listed below are in compliance with Directive 2014/53/EU and with Radio Equipment Regulations 2017 of the United Kingdom. The full text of the EU/UK declarations of conformity are available at the following internet address:

bmw-motorrad.com/certification

Technical information

Radio equipment	Component	Frequency band	Output/Transmission Power
EWS4	EWS	134 kHz	50 dB μ V/m
HUF5794	Keyless Ride	433,92 MHz	10 mW
HUF8485	Keyless Ride	134,45 kHz	42 dB μ V/m

300 APPENDIX

Radio equipment	Component	Frequency band	Output/Transmission Power
ZB001	Keyless Ride	134.5 kHz	allowed 66 dB μ A/ m @ 10m
ZB002	Keyless Ride	433.92 MHz	max. 10 dBm e.r.p
TXBM-WMR	DWA	433.05 MHz - 434.79 MHz	18,8 dBm
RDC3	RDC	433.92 MHz	< 13 mW
Wus Moto gen 3	RDC	433,05 MHz - 434,79 MHz	< 10 mW e.r.p.
MC24MA4	RDC		
WCA Motorrad-Ladestafach	Charging compartment	110 kHz - 115 kHz	< 6 W
ICC6.5in	Instrument Cluster	Bluetooth: 2402 MHz - 2480 MHz WLAN: 2412 MHz - 2462 MHz	Bluetooth: < 4 dBm WLAN: < 20 dBm
ICC65V2	Instrument Cluster	Bluetooth: 2400 MHz - 2480 MHz WLAN: 2400 MHz - 2480 MHz	Bluetooth: < 10 mW WLAN: < 100 mW
ICC10in	Instrument Cluster	Bluetooth: 2402 MHz - 2480 MHz WLAN: 2402 MHz - 2472 MHz	Bluetooth: < 4 dBm WLAN: < 14 dBm

Radio equipment	Component	Frequency band	Output/Transmission Power
MR-Re14FCR	ACC	76 - 77 GHz	Peak max. 32 dBm Nom max. 27 dBm
ARS513	Front radar	77 GHz	Peak max. 30 dBm
SRR521	Rear radar	77 GHz	Peak max. 30 dBm
TL1P22	Intelligent emergency call	832 MHz - 862 MHz 880 MHz - 915 MHz 1710 MHz - 1785 MHz 1920 MHz - 1980 MHz 2500 MHz - 2570 MHz 2570 MHz - 2620 MHz GNSS: 1559 MHz-1610 MHz	23 dBm 33 dBm 30 dBm 24 dBm 23 dBm 23 dBm
TL1M23NE	Intelligent emergency call	703 MHz - 748 MHz 832 MHz - 862 MHz 880 MHz - 915 MHz 1710 MHz - 1785 MHz 1920 MHz - 1980 MHz 2300 MHz - 2400 MHz 2500 MHz - 2570 MHz 2570 MHz - 2620 MHz GNSS: 1559 MHz-1610 MHz	23 dBm 23 dBm 33 dBm 30 dBm 24 dBm 23 dBm 23 dBm 23 dBm
MCR001	Audio system		
ZB005	Keyless Ride Main Unit	134,5 kHz 433,92 MHz	< 66 dB μ A/m

302 APPENDIX

Radio equipment	Component	Frequency band	Output/Transmission Power
ZB006	Keyless Ride Active Key	134,5 kHz 433,92 MHz	< 10 mW e.r.p.

RADIO EQUIPMENT TFT INSTRUMENT CLUSTER

For all countries without EU

Model name: ICC65V2 Manufacturer

Robert Bosch GmbH
Robert-Bosch-Platz 1, 70839
Gerlingen, Germany

Technical Information

BT operating frq. Range: 2402 -
2480 MHz

BT version: 4.2 (no BTLE)

BT output power: < 4 dBm

WLAN operating frq. Range:
2412 - 2462 MHz

WLAN standards:

IEEE 802.11 b/g/n

WLAN output power: < 20 dBm

Country

Canada

This device complies with Industry Canada's licence-exempt RSSs and part 15 of the FCC Rules. Operation is subject to the following two conditions:

(1) this device may not cause interference, and

(2) this device must accept any interference, including interference that may cause undesired operation of the device.

Changes or modifications not expressly approved by the party responsible for compliance could void the user's authority to operate the equipment.

Le présent appareil est conforme aux CNR d'Industrie Canada applicables aux appareils radio exempts de licence.

L'exploitation est autorisée aux deux conditions suivantes :

(1) l'appareil ne doit pas produire de brouillage, et

(2) l'appareil doit accepter tout brouillage radioélectrique subi, même si le brouillage est susceptible d'en compromettre le fonctionnement.

Radio Frequency (RF) Exposure Information

The radiated output power of the Wireless Device is below the Industry Canada (IC) radio frequency exposure limits. The Wireless Device should be used in such a manner such that the potential for human contact during normal operation is minimized. This device has also been evaluated and shown compliant with the IC RF Exposure limits under mobile exposure conditions.

304 APPENDIX

Informations concernant l'exposition aux fréquences radio (RF)

La puissance de sortie émise par l'appareil de sans fil est inférieure à la limite d'exposition aux fréquences radio d'Industry Canada (IC). Utilisez l'appareil de sans fil de façon à minimiser les contacts humains lors du fonctionnement normal. Ce périphérique a également été évalué et démontré conforme aux limites d'exposition aux RF d'IC dans des conditions d'exposition à des appareils mobiles (antennes sont supérieures à 20 cm à partir du corps d'une personne).

Mexico

La operación de este equipo está sujeta a las siguientes dos condiciones:

- (1) es posible que este equipo o dispositivo no cause interferencia perjudicial y
- (2) este equipo o dispositivo debe aceptar cualquier interferencia, incluyendo la que pueda causar su operación no deseada.

Paraguay



NR.: 2023-03-I-0156

KEYLESS RIDE SYSTEM MAIN UNIT

For all countries without EU

Model name: ZB005

Manufacturer

ZADI S.p.A.

Via Carlo Marx 138, 41012 Carpi (MO), Italy

Technical Information

Nominal voltage:

13,5 V

Operating voltage:

6,7 - 16 V

Operating temperature:

-20 °C - +60 °C

Operating frequency LF:

134,5 kHz

Operating frequency HF:

433,92 MHz

RF power:

< 66 dB μ A/m

IP grade:

IP5K6K

Country
Argentina



H-28764

Australia/New Zealand



R-NZ

Brunei



Ref. Num.: DTA-022593

Canada

IC: 22239-KLRMZB005

This device complies with Industry Canada licence-exempt RSS standard(s). Operation is subject to the following two conditions:

- (1) this device may not cause interference, and
- (2) this device must accept any interference, including interference that may cause

undesired operation of the device.

This Class B digital device complies with Canadian ICES-003.

Le présent appareil est conforme aux CNR d'Industrie Canada applicables aux appareils radio exempts de licence. L'exploitation est autorisée aux deux conditions suivantes :

- (1) l'appareil ne doit pas produire de brouillage, et
- (2) l'appareil doit accepter tout brouillage radioélectrique subi, même si le brouillage est susceptible d'en compromettre le fonctionnement.

Cet appareil numérique classe B est conforme à la norme Canadien NMB-003.

Hong Kong

Certified for use in Hong Kong Certification No. HK0012202803

India

ZB005 Registration Number: ETA-SD-20221109924

Indonesia



73343/SDPPI/2021

306 APPENDIX

13349

Israel

ZADI S.P.A ITALY : רתייה לעב מש

ZB005 : סמ רושיא ןרא : Italy מגד

. 5172747 נטנאה תא פילחהל רוטא

ה 434.79- 433.05 MHz רשואמ

קפס רשא 10.MW מירדת סוחתל

הלוע וניא רודישה

Jordan

BMW Keyless Ride System is in conformity with Jordanian technical requirements.

Malaysia



RFDT/45A/1222/S(22-5677)

Mexico

Advertencias de IFETEL

La operación de este equipo está sujeta a las siguientes dos condiciones:

(1) es posible que este equipo o dispositivo no cause interferencia perjudicial y;

(2) este equipo o dispositivo debe aceptar cualquier interferencia, incluyendo la que pueda causar su operación no deseada.

ZB005 Certificado
Homologacion Numero:
BMBMZB22-28194

Morocco

AGREE PAR L'ANRT MAROC

Numéro d'agrément:

MR00035262ANRT2022

Date d'agrément: 14/11/2022

Nigeria

The equipment has been found to comply with the standards of the Commission and therefore approved for connection to the Nigerian Telecommunication Network, or for use in Nigeria.

Pakistan



Approved by PTA
TAC NO: 9.110/2021

Paraguay



NR: 2023-01-I-0035

Philippines

Type Approved
No.: ESD-RCE-2231813

Serbia

U005 22

Singapore

Complies with
IMDA Standards
DA105282

Sultanate of Oman

TRA/TA-R/14769/22
D100428

South Africa

TA-2022/3277

Taiwan

取得審驗證明之低功率射頻器材，非經核准，公司、商號或使用者均不得擅自變更頻率、加大功率或變更原設計之特性及功能。低功率射頻器材之使用不得影響飛航安全及干擾合法通信；經發現有干擾現象時，應立即停用，並改善至無干擾時方得繼續使用。前述合法通信，指依電信管理法規定作業之無線電通信。低功率射頻器材須忍受合法通信或工業、科學及醫療用電波輻射性電機設備之干擾

Vietnam**KEYLESS RIDE SYSTEM
ACTIVE KEY**

For all countries without EU

308 APPENDIX

Model name: ZB006

Manufacturer

ZADI S.p.A.

Via Carlo Marx 138, 41012 Carpi
(MO), Italy

Technical Information

Battery type

CR2032

Nominal voltage:

3 V

Operating voltage:

2,5 - 3,16 V

Operating temperature:

-20 °C - +60 °C

Operating frequency LF:

134,5 kHz

Operating frequency HF:

433,92 MHz

RF power:

< 10 mW e.r.p.

IP grade:

IP5K7

Country

Argentina



H-28765

Australia/New Zealand



R-NZ

Brunei



Ref. Num.: DTA-022594

Canada

IC: 22239-KLRKZB006

This device complies with Industry Canada licence-exempt RSS standard(s). Operation is subject to the following two conditions:

- (1) this device may not cause interference, and
- (2) this device must accept any interference, including interference that may cause undesired operation of the device.

This Class B digital device complies with Canadian ICES-003.

Le présent appareil est conforme aux CNR d'Industrie Canada applicables aux appareils radio exempts de licence.

L'exploitation est autorisée aux deux conditions suivantes :

(1) l'appareil ne doit pas produire de brouillage, et

(2) l'appareil doit accepter tout brouillage radioélectrique subi, même si le brouillage est susceptible d'en compromettre le fonctionnement.

Cet appareil numérique classe B est conforme à la norme Canadien NMB-003.

Hong Kong

Certified for use in Hong Kong
Certification No. HK0012202804

India

ZB005 Registration Number:
ETA-SD-20221109929

Indonesia



73333/SDPPI/2021
13349

Israel

רתייה לעב שם: ZADI S.P.A ITALY
רושיא Italy: ירא ZB006 סגד:
תא פילחלה רוסא 5172748 סמ.
MHz מירדת מוחתל רשואמ הנטגא
רודישה קפס רשא 433.05-434.79
MW.10 הלוע וניא

Jordan

BMW Keyless Ride System is in conformity with Jordanian technical requirements.

Malaysia



RFDT/44A/1222/S(22-5676)

Mexico

Advertencias de IFETEL
La operación de este equipo está sujeta a las siguientes dos condiciones:

(1) es posible que este equipo o dispositivo no cause interferencia perjudicial y;

(2) este equipo o dispositivo debe aceptar cualquier interferencia, incluyendo la que pueda causar su operación no deseada.

ZB006 Certificado
Homologacion Numero:
BMBMZB22-28198

Morocco

AGREE PAR L'ANRT MAROC
Numéro d'agrément:
MR00035261ANRT2022
Date d'agrément: 14/11/2022

310 APPENDIX

Nigeria

The equipment has been found to comply with the standards of the Commission and therefore approved for connection to the Nigerian Telecommunication Network, or for use in Nigeria.

Oman

TR/TA-R/14770/22
D100428

Pakistan



Approved by PTA
TAC NO: 9.111/2021

Paraguay



NR: 2023-01-I-0036

Philippines



Type Approved
No.: ESD-RCE-2231812

Serbia



I005 22

Singapore

Complies with
IMDA Standards
DA105282

South Africa



TA-2022/2861

Taiwan



取得審驗證明之低功率射頻器材，非經核准，公司、商號或使用者均不得擅自變更頻率、加大功率或變更原設計之特性及功能。低功率射頻器材之使用不得影響飛航安全及干擾合法通信；經發現有干擾現象時，應立即停用，並改善至無干擾時方得繼續使用。前述合法通信，指依電信管理法規定作業之無線電通信。低功率射頻器材須忍受合法通信或工業、科學及醫療用電波輻射性電機設備之干擾

Vietnam



MID RANGE RADAR

For all countries without EU

Model name: ARS513/ARS5-B

Manufacturer

ADC Automotive Distance
Control Systems GmbH
Peter-Dornier-Straße 10, 88131
Lindau, Germany

Technical information

Frequency band: 76 - 77 GHz
Output/Transmission power:
2,0 W (33 dBm RMS EIPR)

Country

Argentina



C-22292

Australia/New Zealand



Canada

Model: ARS5-B

IC: 4135A-ARS5B

This device complies with Industry Canada licence-exempt RSS standard(s). Operation is subject to the following two conditions:

- (1) this device may not cause interference.
- (2) this device must accept any interference, including interference that may cause

312 APPENDIX

undesired operation of the device.

Radiofrequency radiation exposure Information: This equipment complies with IC radiation exposure limits set forth for an uncontrolled environment. This equipment should be installed and operated with minimum distance of 20 cm between the radiator and your body. This transmitter must not be colocated or operating in conjunction with any other antenna or transmitter.

Le présent appareil est conforme aux CNR d'Industrie Canada applicables aux appareils radio exempts de licence.

L'exploitation est autorisée aux deux conditions suivantes :

(1) l'appareil ne doit pas produire de brouillage;

(2) l'utilisateur de l'appareil doit accepter tout brouillage radioélectrique subi, même si le brouillage est susceptible d'en compromettre le fonctionnement.

Informations sur l'exposition aux radiofréquences: Cet équipement est conforme aux limites d'exposition aux rayonnements IC établies pour un environnement non contrôlé. Cet équipement doit être installé

et utilisé avec un minimum de 20 cm de distance entre la source de rayonnement et votre corps. Ce transmetteur ne doit pas être placé au même endroit ou utilisé simultanément avec un autre transmetteur ou antenne.

Indonesia



77406/SDPPI/2021
2651

Israel

רישכמב תולועפ עצבל רוסיא לה
דיתונוכת תא תונשל ידכ והב שיש
הז ללכבו, רישכמה לש תויטוחלאה
ייוניש

וא תירוקמ הנטנא תפלחה, הנכות
הנטנאל רוביחל תורשפא תפסוה
דרשמ רושיא תלבק אלב, תינוציח
תרושקהת,
תויטוחלא תוערפהל ששחה לשב.

Malaysia



CIDF15000490

Mexico

IFT: RCPCOAR18-1800

Philippines

Type Approved

No. ESD-1817853C

Serbia

M011 18

Singapore

Complies with
IMDA Standards
DA 101586

South Africa

TA-2018/2868
APPROVED

Sultanate of Oman

OMAN - TRA

D172249

TRA/TA-R/6132/18

Taiwan**警語**

經型式認證合格之低功率射頻電機,非經許可,公司、商號或使用者均不得擅自變更頻率、加大功率或變更原設計之特性及功能。

低功率射頻電機之使用不得影響飛航安全及干擾合法通信;經發現有干擾現象時,應立即停用,並改善至無干擾時方得繼續使用。

前項合法通信,指依電信法規定作業之無線電通信。低功率射頻電機須忍受合法通信或工業、科學及醫療用電波輻射性電機設備之干擾。

Vietnam

SUNTECH VN
C00082015

314 APPENDIX

SHORT RANGE RADAR

For all countries without EU

Model name: SRR521/SRR5-B

Manufacturer

ADC Automotive Distance
Control Systems GmbH
Peter-Dornier-Straße 10, 88131
Lindau, Germany

Technical information

Frequency band: 76 - 77 GHz
Output/Transmission power:
1,58 W (32 dBm RMS EIPR)

Country

Argentina



C-21097

Australia/New Zealand



Canada

Model: SRR5-B

IC: 4135A-SRR5B

This device complies with Industry Canada licence-exempt RSS standard(s). Operation is subject to the following two conditions:

(1) this device may not cause interference.

(2) this device must accept any interference, including interference that may cause undesired operation of the device.

Radiofrequency radiation exposure Information: This equipment complies with IC radiation exposure limits set forth for an uncontrolled environment.

This equipment should be installed and operated with minimum distance of 20 cm between the radiator and your body. This transmitter must not be colocated or operating in conjunction with any other antenna or transmitter.

Le présent appareil est conforme aux CNR d'Industrie Canada applicables aux appareils radio exempts de licence.

L'exploitation est autorisée aux deux conditions suivantes :

(1) l'appareil ne doit pas produire de brouillage;

(2) l'utilisateur de l'appareil doit accepter tout brouillage radioélectrique subi, même si le brouillage est susceptible d'en compromettre le fonctionnement.

Informations sur l'exposition aux radiofréquences: Cet équipement est conforme aux limites d'exposition aux rayonnements IC établies pour un environnement non contrôlé. Cet équipement doit être installé et utilisé avec un minimum de 20 cm de distance entre la source de rayonnement et votre corps. Ce transmetteur ne doit pas être placé au même endroit ou utilisé simultanément avec un autre transmetteur ou antenne.

Indonesia



83878/SDPPI/2022
13349

Israel

רישכמב תולועפ עצבל רוסיא לח
ויתונכת תא תונשל ידכ והב שיש

הז ללכבו, רישכמה לש תויטוחלאה
ידיניש

וא תירוקמ הנטנא תפלחה, הנכות
הנטנאל רוביחל תורשפא תפסדה
דרשמ רושיא תלבק אלב, תינוציה
תרושקתה,
תויטוחלא תוערפהל ששחה לשב.

Malaysia



CIDF15000490

Mexico

IFT: RCPCOSR20-2859

Paraguay



2020-11-I-0870

Serbia



И011 19

316 APPENDIX

Singapore

Complies with
IMDA Standards
DA 101586

South Africa



TA-2019/5066
APPROVED

Sultanate of Oman

OMAN - TRA
D172249
TRA/TA-R/10407/20

Taiwan

警語

經型式認證合格之低功率射頻電機,非經許可,公司、商號或使用者均不得擅自變更頻率、加大功率或變更原設計之特性及功能。

低功率射頻電機之使用不得影響飛航安全及干擾合法通信;經發現有干擾現象時,應立即停用,並改善至無干擾時方得繼續使用。

前項合法通信,指依電信法規定作業之無線電通信。低功率射頻電機須忍受合法通信或工業、科學及醫療用電波輻射性電機設備之干擾。

Vietnam



SUNTECH VN
C00082015

RADIO EQUIPMENT TYRE PRESSURE CONTROL (RDC)

For all countries without EU

Model name:

Wus moto gen 3

Manufacturer

LDL Technology S.A.S.
Parc Technologique du Canal,
3 rue Giotto, 31520 Ramonville,
France

Technical information

Frequency band: 433,92 MHz
Maximum effective radiated
power: 16,75 dBm

Country

Argentina



H-23422

Australia**Malaysia**

RBEF/29A/0919/S(19-3776)

MexicoIFETEL: IFT/223/UCS/DG-AUSE/
2418/2019**Morocco**

AGREE PAR L'ANRT MAROC

Numéro d'agrément :

MR 20577 ANRT 2019

Date d'agrément :

26/07/2019

Singapore

Complies with

IMDA Standards

N3305-19

South Africa

TA-2019/1178

APPROVED

Taiwan

第十二條 經型式認證合格之低功率射頻電機，非經許可，公司、商號或使用者均不得擅自變更頻率、加大功率或變更原設計之特性及功能。第十四條 低功率射頻電機之使用不得影響飛航安全及干擾合法通信；經發現有干擾現象時，應立即停用，並改善至無干擾時方得繼續使用。前項合法通信，指依電信法規定作業之無線電通信。低功率射頻電機須忍受合法通信或工業、科學及醫療用電波輻射性電機設備之干擾。

**RADIO EQUIPMENT
INTELLIGENT EMERGENCY
CALL**

For all countries without EU

318 APPENDIX

Model name: TL1M23NE
Manufacturer

LG ELECTRONICS INC.
10, Magokjungang 10-ro,
Gangseo-gu Seoul, Republic of
Korea

Country

Canada

IC: US0186.2022.000413
This equipment complies with
IC radiation exposure limits
set forth for an uncontrolled
environment. This equipment
should be installed and operated
with minimum distance 3.5 cm
between the radiator & your
body. Operation is subject to the
following two conditions:

- (1) this device may not cause
interference, and
- (2) this device must accept
any interference, including
interference that may cause
undesired operation of the
device.

The manufacturer is not
responsible for any radio or
tv interference caused by
unauthorized modifications
to this equipment. Such
modifications could void the
user's authority to operate the
equipment.

Avis d'Industrie Canada sur
l'exposition aux rayonnements
Cet appareil est conforme
aux limites d'exposition aux
rayonnements d'Industrie
Canada pour un environnement
non contrôlé. Il doit être installé
de façon à garder une distance
minimale de 3.5 centimètres
entre la source de rayonnements
et votre corps. L'exploitation est
autorisée aux deux conditions
suivantes :

- (1) l'appareil ne doit pas produire
de brouillage, et
- (2) l'appareil doit accepter
tout brouillage radioélectrique
subi, même si le brouillage est
susceptible d'en compromettre
le fonctionnement.

Le fabricant n'est pas
responsable des interférences
radioélectriques causées par des
modifications non autorisées
apportées à cet appareil. de
telles modifications pourrait
annuler l'autorisation accordée à
l'utilisateur de faire fonctionner
l'appareil.

320 INDEX

A

Abbreviations and symbols, 4

ABS

Engineering details, 172

Self-diagnosis, 153

Status indicators, 62

Warning indicators, 62, 63

ACC

activating, 115

deactivating, 115

Engineering details, 180

operating, 116

Safety information, 112, 114

Status indicators, 117

Warning light, 69, 70

Accessories

general notes, 236

Active cruise control

Warning light, 69

Air filter

installing, 221

Position in the vehicle, 19

removing, 220

Ambient temperature, 47

Anti-theft alarm

Indicator light, 24

operating, 124

Technical data, 273

B

Battery

connecting to motorcycle, 228

disconnecting from motorcycle, 227

installing, 229

Maintenance instructions, 225

recharging connected battery, 226

recharging disconnected

battery, 227

removing, 228

Technical data, 273

Warning indicators, 48, 49, 50, 51

Bluetooth, 82

Brake fluid

Checking fluid level, front, 207

Checking fluid level, rear, 208

Reservoir, front, 19

Reservoir, rear, 19

Brake pads

checking front, 205

checking rear, 206

Running in, 155

Brakes

ABS Pro in detail, 175

ABS Pro depending on riding mode, 159

Adjust the footbrake lever, 142

Adjusting handlebar levers, 141

Checking operation, 204

Dynamic Brake Control depending on riding

mode, 159

Safety information, 158

Technical data, 270

Braking, 33

C

Care

Care products, 254

Chrome, 256

Paintwork preservation, 257

- Radar sensors, 256
- Washing the vehicle, 254
- Cases, 239
- Central locking
 - operating, 130
- Chassis and suspension
 - Technical data, 270
- Check control
 - Dialogue, 37
 - Display, 37
- Clutch
 - Adjusting handlebar levers, 140
 - Checking operation, 209
 - Technical data, 269
- Coolant
 - Checking fill level, 209
 - topping up, 210
- Cornering headlight
 - Engineering details, 195
- Cruise control
 - operating, 109

D

- Daytime riding lights
 - automatic daytime riding light, 101
- Diagnostic connector
 - disengaging, 233
 - securing, 233
- Dimensions
 - Technical data, 273
- Drop sensor
 - Warning light, 61

- DTC, 33
 - Engineering details, 176
 - operating, 103
 - Self-diagnosis, 154
 - Warning indicators, 63, 64, 65
- DWA
 - Warning indicator lights, 53
 - Warning indicators, 52, 53
- Dynamic Brake Control, 190
 - Engineering details, 190
- Dynamic engine brake control, 178

E

- Electrical system
 - Technical data, 272
- Emergency call
 - Automatically in the event of a light fall, 99
 - Automatically in the event of a severe fall, 100
 - Language, 98
 - manual, 98
 - Notes, 12
 - Warning indicators, 61
- Emergency off switch (kill switch), 22, 23
 - operating, 97
- Emergency-call system
 - Control, 23
- Engine
 - starting, 152
 - Technical data, 268
 - Warning indicator lights, 56
 - Warning indicators, 56, 57
- Engine oil
 - Checking fill level, 202
 - Electronic oil-level check, 53

322 INDEX

Filler neck, 19
Fill-level indicator, 19
Indicator light for engine oil level, 54
Technical data, 268
topping up, 204
Engine temperature, 54, 55
ESA
operating, 103

F

Final drive
Technical data, 269
Frame
Technical data, 269
Frontkollisionswarnung
Engineering details, 182
operating, 118
Safety information, 118
Front-wheel stand
installing, 201
Fuel
Filler neck, 18
Fuel grade, 163
refuelling, 164, 165
Technical data, 267
Fuel filler cap emergency release, 166
Fuel reserve
Range, 32
Warning indicators, 68
Fuses
replacing, 231

G

General views, 33
Indicator and warning lights, 28
Instrument cluster, 24, 29, 30

Left multifunction switch, 21
left side of vehicle, 18
My vehicle, 34
Right multifunction switch, 22, 23
right side of vehicle, 19
Underneath the seat, 20

H

Handlebars
adjusting, 143
Hazard warning flashers
Control, 21
Headlight
Headlight beam throw, 139
Headlight courtesy delay feature, 100
Heated handlebar grips
operating, 128
heel angle, 33
Hill Start Control, 121, 193
cannot be activated, 69
Engineering details, 193
Indicator and warning lights, 68
operating, 122
switching on and off, 121
Hill Start Control Pro
adjusting, 123
Engineering details, 193
operating, 122
Horn, 21

I

Ignition
Control, 22, 23
Immobiliser
Spare key, 94

- Indicator lights, 24
 - Overview, 28
- Instrument cluster
 - Overview, 24
- Instrument panel, 24
 - Ambient-light brightness sensor, 24
 - operating, 74, 79, 81
 - Overview, 29, 30

J

- Jump-starting, 223

K

- Keyless Ride
 - Battery of the radio-operated key is empty or loss of the radio-operated key, 94
 - Locking the steering lock, 92
 - Switching off ignition, 93
 - Switching on ignition, 93
 - Warning indicators, 47, 48

- Keys, 92

L

- Lane change warning
 - Engineering details, 183
 - Warning light, 70, 71
- Lifting on to stand, 161
- Lighting
 - Replacing LED light sources, 223
 - Technical data, 273
 - Warning indicators, 51
- Lights
 - automatic daytime riding light, 101
 - Control, 21
 - Cornering headlight, 195

- Headlight courtesy delay feature, 100
- Headlight flasher, operating, 100
- High-beam headlight, operating, 100
- Low-beam headlight, 100
- Operating auxiliary headlights, 101
- Parking lights, 101
- Side light, 100
- Luggage
 - Instructions for loading, 148

M

- Maintenance
 - Maintenance schedule, 282
- Maintenance confirmations, 284
- Maintenance intervals, 280
- Media
 - operating, 87
- Menu
 - calling up, 79
- Mirrors
 - adjusting, 138
- Mobility services, 280
- Motorcycle care, 252
 - cleaning, 252
 - lashing, 166
 - laying up, 257
 - parking, 160
 - restoring to use, 258
- Multifunction display
 - Control, 21

324 INDEX

Multifunction switch
 Overview, left side, 21
 Overview, right side, 22, 23

N

Navigation
 operating, 85

O

Off-roading, 156
On-board computer, 80
On-board voltage, 48, 49
Operating focus
 change, 84

P

Pairing, 82
Parking, 160
Parking light, 101
Performance figures
 Technical data, 275
Phone
 operating, 88
Power socket
 Notes on use, 236
 Position on the vehicle, 19
Pre-Ride-Check, 152
Pure Ride
 Overview, 30

R

Radio-operated key
 Warning indicators, 47, 48
RDC
 Engineering details, 190
 Warning indicators, 57, 58,
 59, 60
Rear-wheel stand
 installing, 202
Recycling, 279

Refuelling
 Fuel filler cap, unlocking, 164,
 165
 Fuel grade, 163
Remote control
 Replacing battery, 95
Rev. counter, 24
 Rev. counter, 31
Riding height
 adjusting, 104
Riding mode
 adjusting, 105
 Control, 22, 23
 Engineering details, 185
 Setting up Pro riding
 mode, 108
Riding-mode preselection, 105
Running in, 155

S

Safety instructions
 for brakes, 158
 for riding, 148
Screw connections, 264
Seat
 Position of the height
 adjuster, 20
Seat heating
 operating, 128
Seats
 Lock, 18
 Removing and installing, 133
Service, 279
 Reporting safety-relevant
 defects, 278
 Service history, 280
 Warning indicators, 72
Service-due indicator, 72

- Shift assistant
 - Engineering details, 192
 - Gear not taught, 71
 - Riding, 157
- Shift lever
 - Adjusting peg, 140
- ShiftCam, 195
 - Engineering details, 195
- Shifting gear
 - Recommendation to upshift, 32
- Spark plugs
 - Technical data, 273
- Speed Limit Info, 87
- Speedometer, 24
- Spring preload
 - Adjuster, rear, 19
 - adjusting, 144
- Starting, 152
 - Control, 22, 23
- Status line, top, 81
 - adjusting, 81
- T**
- Technical data, 273
 - Anti-theft alarm, 273
 - Battery, 273
 - Brakes, 270
 - Chassis and suspension, 270
 - Clutch, 269
 - Dimensions, 273
 - Electrical system, 272
 - Engine, 268
 - Engine oil, 268
 - Final drive, 269
 - Frame, 269
 - Fuel, 267
 - Performance figures, 275
 - Spark plugs, 273
 - Transmission, 269
 - Weights, 275
 - Wheels and tyres, 271
- Toolkit
 - Position on the vehicle, 20
- Topcase
 - operating, 244
- Torques, 264
- Traction control, 176
 - DTC, 176
- Transmission
 - Technical data, 269
- Troubleshooting chart, 262
- Turn indicators
 - Control, 21
- Type plate
 - Position on the vehicle, 19
- Tyre pressure monitoring RDC
 - Display, 35
- Tyres
 - Checking tread depth, 210, 211
 - Checking tyre pressure, 210
 - Pressures, 272
 - Running in, 155
 - Table of tyre pressures, 18, 20
 - Technical data, 271
 - Top speed, 149
- V**
- Value
 - Display, 37
- Vehicle Identification Number
 - Position on the vehicle, 19

326 INDEX

W

- Warning indicator lights, 50, 51
 - ABS, 62, 63
 - Anti-theft alarm, 53
 - Bulb faulty, 51
 - Cruise control, 69
 - Distance control (Active Cruise Control ACC), 69
 - Drop sensor, 61
 - DTC, 63, 64, 65
 - DWA, 52, 53
 - Electrical machine control unit, 56, 57
 - Electrical machine temperature, 54, 55
 - Emergency call, 61
 - Engine, 56
 - Engine electronics, 56
 - Engine oil level, 54
 - Front collision warning, 70
 - Fuel reserve, 68
 - Gear not taught, 71
 - Hill Start Control, 68, 69
 - Keyless Ride, 47, 48
 - Lane change warning (SWW), 70, 71
 - Light control failed, 52
 - Mode of presentation, 37
 - My vehicle, 34
 - On-board voltage, 48, 49
 - Outside temperature warning, 47
 - RDC, 57
 - Service, 72
 - Side stand, 61
 - TPM, 58, 59, 60
 - Warning light, drive malfunction, 55
- Warning light, drive malfunction, 55
- Warning lights, 24
 - Overview, 28
- Warnings, overview, 39
- Weights
 - Payload table, 18, 20
 - Technical data, 275
- Wheels
 - Change of size, 212
 - Check the spokes, 212
 - Checking rims, 212
 - Installing front wheel, 215
 - Installing rear wheel, 218
 - Removing front wheel, 213
 - Technical data, 271
- Windscreen
 - adjusting, 127

Details described or illustrated in this booklet may differ from the vehicle's actual specification as purchased, the accessories fitted or the national-market specification. No claims will be entertained as a result of such discrepancies.

Dimensions, weights, fuel consumption and performance data are quoted to the customary tolerances.

The right to modify designs, equipment and accessories is reserved.

Errors and omissions excepted.





© 2023 Bayerische Motoren
Werke Aktiengesellschaft
80788 Munich, Germany

Not to be reproduced by any means whatsoever, wholly or in part, without the written permission of BMW Motorrad, After Sales.

Original rider's manual, printed in Germany.

Important data for refuelling:

Fuel

Recommended fuel grade	 Premium unleaded (max 15 % ethanol, E10/E15)  95 ROZ/RON 90 AKI
Alternative fuel grade	 Normal unleaded (power- and consumption-related restrictions.) (max 15 % ethanol, E10/E15)  91 ROZ/RON 87 AKI
Usable fuel capacity	approx. 19 l
Reserve fuel	approx. 4 l
Tyre pressures	
Tyre pressure, front	2.5 bar, tyre cold
Tyre pressure, rear	2.9 bar, tyre cold

For further information on all aspects of your vehicle, visit: [bmw-motorrad.com](https://www.bmw-motorrad.com)

